

## ELEMENTS OF DRINK DESIGN

Much like a well-designed object, a well-crafted cocktail takes into account the contributions of each element and how they play against each other. Balance and tension, comfort and elevation, the nuances of technique and ingredient make each cocktail unique.

### *The Elements of a Cocktail*

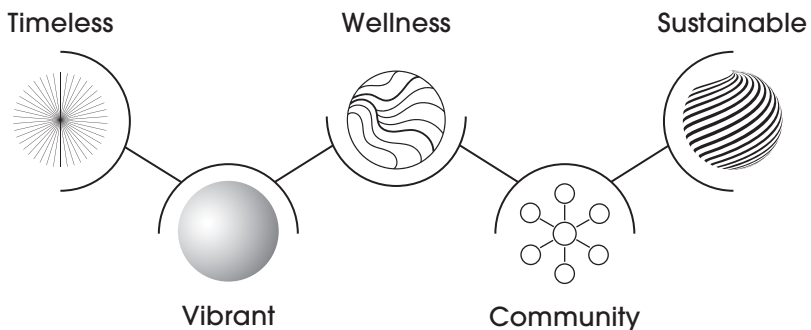

## Cocktails



### **BUILD YOUR OWN HIGHBALL 16**

#### Choose your Spirit:

#### **VODKA**

Tito's Handmade  
Belvedere Organic  
Grey Goose

#### **TEQUILA**

Herradura Silver  
Casamigos Reposado  
Milagro Añejo

#### **BOURBON**

Bulleit  
Maker's Mark  
Woodford Reserve

#### Choose your Mixer:

Q Club Soda  
Owen's Rio Red Grapefruit  
Owen's American Tonic  
Q Ginger Ale  
Owen's Ginger Beer

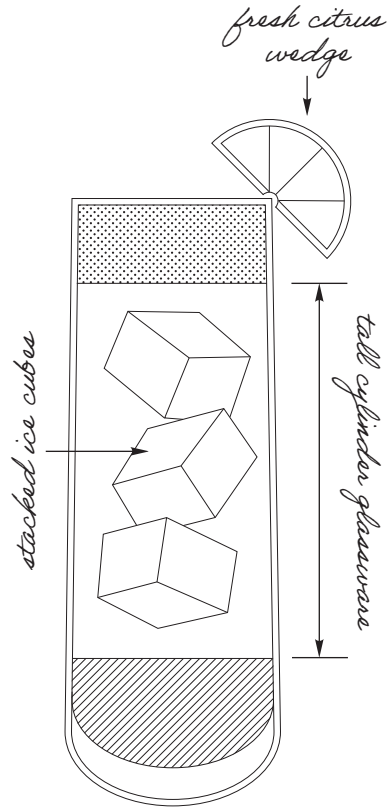

*composed of an alcoholic base spirit and a larger proportion of a non-alcoholic mixer.*



### **AMERICANO HIGHBALL 19**

Campari, Antica Formula Sweet  
Vermouth, Q Club Soda

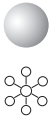

**OF ALL THINGS 16**

21 Seeds Grapefruit Hibiscus  
Tequila, Aperol, Barmalade  
Grapefruit-Elderflower,  
fresh lime, rhubarb bitters,  
Lunetta Prosecco

*edible micro  
flowers*

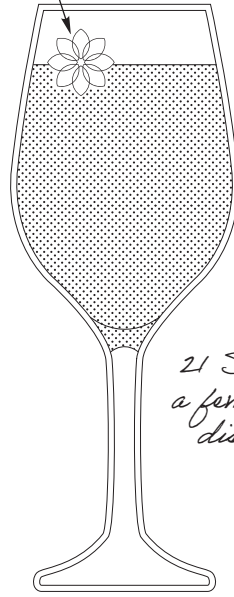

*21 Seeds is  
a female-led  
distillery*

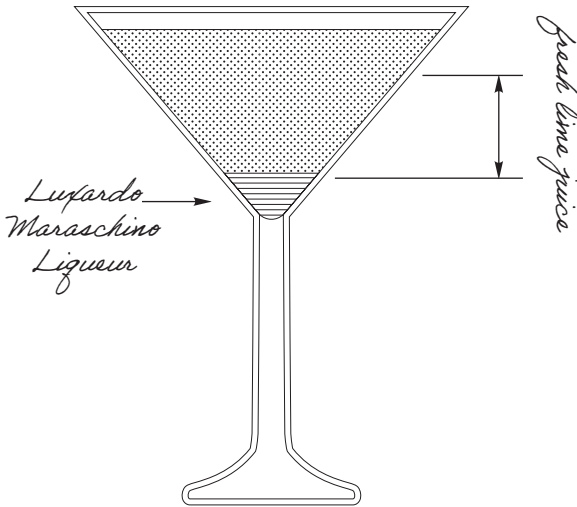

*Luxardo  
Maraschino  
Liqueur*

*fresh lime juice*



**THE LAST WORD MARTINI 16**

Hendrick's Gin, green chartreuse,  
Luxardo Maraschino Liqueur,  
fresh lime

*Make it smoky with Dos Hombres Mezcal 18*

**ELEMENT KEY**

 Timeless

 Vibrant

 Wellness

 Community

 Sustainable

Cocktails

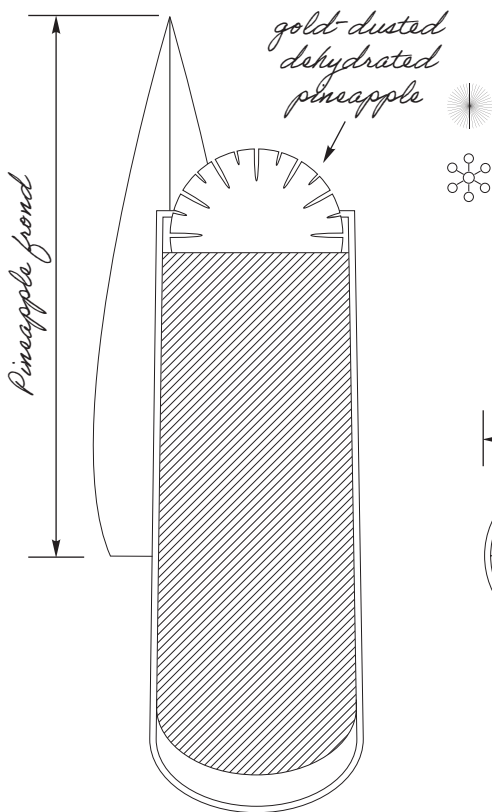



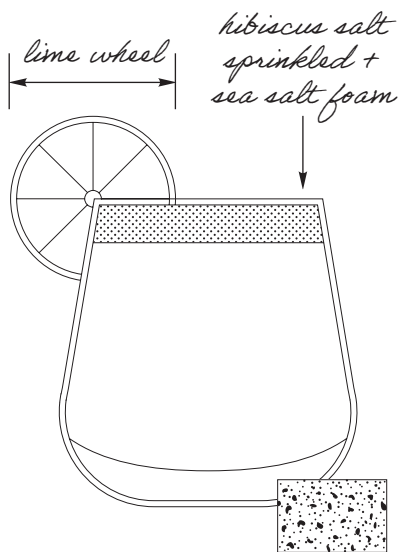

**JUNGLE BIRD 16**

Appleton Estate Signature Blend Rum, Campari, Liber & Co. Pineapple Gum Syrup, fresh lime, pineapple juice



*spiced/smoked version:  
tajin rim + chili threads*

| ELEMENT KEY   |             |
|---|-------------|
|  | Timeless    |
|  | Vibrant     |
|  | Wellness    |
|  | Community   |
|  | Sustainable |

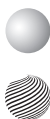

**MARGARITA 16**

Patrón Silver Tequila, Italicus Rosolio di Bergamotto, fresh lime, Monin Agave Nectar

*Level up with Herradura Reposado 19*

*Make it spicy with Ancho Reyes*

*Chile Liqueur 18*

*Try it smoky with Dos Hombres Mezcal 18*



**CLASSIC MARTINI**

**DRY / STIRRED 16**

The Botanist Gin or  
Ketel One Vodka, Carpano  
Dry Vermouth, orange bitters,  
lemon twist

**DIRTY / SHAKEN 18**

Tito's Handmade Vodka,  
Carpano Bianco Vermouth,  
house brine, Filthy Foods Olive  
Accoutrements

*dirty version:  
Filthy Foods olive  
accoutrements*



*3 espresso beans*

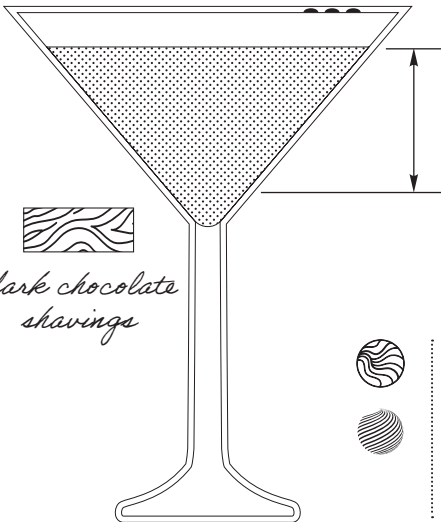

*fresh-brewed  
espresso*

*dark chocolate  
shavings*



**ESPRESSO MARTINI 17**

Absolut Vodka, Kahlúa,  
fresh espresso

*Twist it up with Casamigos  
Reposado Tequila 19*

Cocktails

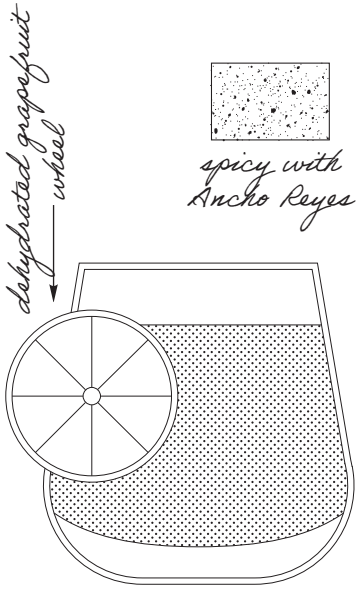

*originally called the "De Requieur" in cocktail books*

**BROWN DERBY 17**

Woodford Reserve Bourbon, fresh grapefruit, barrel-aged maple syrup, orange bitters

*Spice it up with Ancho Reyes Chile Liqueur 19*

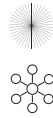

*traditional rye whiskey*

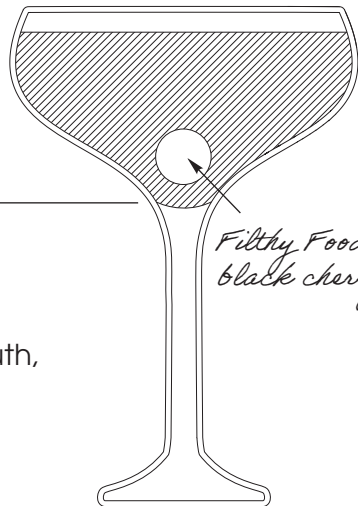

**MANHATTAN 17**

Knob Creek 7 Yr. Rye Whiskey, Antica Formula Sweet Vermouth, Angostura Bitters



*Filthy Foods  
black cherry*

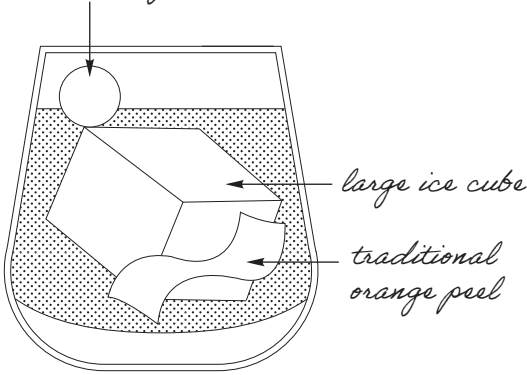

**OLD FASHIONED 17**

High West Bourbon, Liber & Co Demerara Syrup,  
El Guapo Bitters

*Level up with Garrison Brothers Small Batch Bourbon 25*

*Make it a twist featuring Cincoro Reposado Tequila 32*

**ELEMENT KEY**



Timeless



Vibrant



Wellness



Community



Sustainable

***Mocktails***

*candied ginger slice*

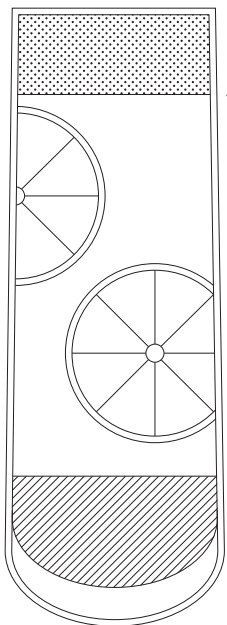

*lemon wheels in cocktail*



**SEAMLESS 12**

Monin Vanilla, Passion Fruit Reàl, fresh lemon, Q Club Soda



| ELEMENT KEY |             |
|-------------|-------------|
|             | Timeless    |
|             | Vibrant     |
|             | Wellness    |
|             | Community   |
|             | Sustainable |

*dehydrated blood orange wheel*

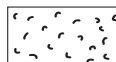
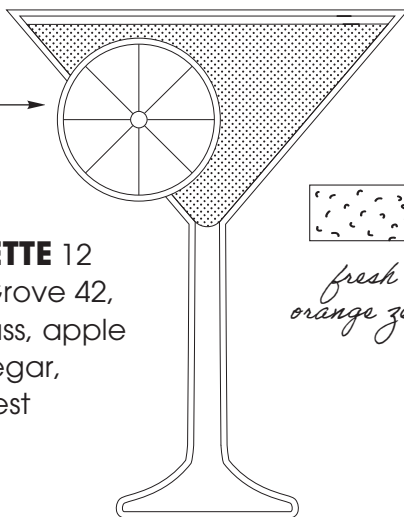

*fresh orange zest*



**SILHOUETTE 12**

Seedlip Grove 42, lemongrass, apple cider vinegar, orange zest



**DOMESTIC** 7

MICHELOB ULTRA  
COORS LIGHT  
MILLER LITE  
BUD LIGHT  
BUDWEISER

**IMPORTED** 8

CORONA EXTRA  
DOS EQUIS LAGER  
HEINEKEN  
PERONI  
STELLA ARTOIS  
GUINNESS  
MODELO ESPECIAL

**NON-ALCOHOLIC** 6

HEINEKEN 0.0 NA LAGER  
ATHLETIC BREWING CO  
RUN WILD NA IPA

**CRAFT** 8

SAMUEL ADAMS BOSTON LAGER  
SAMUEL ADAMS SEASONAL  
NEW BELGIUM FAT TIRE ALE  
NEW BELGIUM VOODOO  
RANGER IPA  
BLUE MOON BELGIAN WHITE  
MOCAMA COSMICO IPA  
YUENGLING AMERICAN LAGER

**HARD SELTZERS**

**& CIDERS** 8

ANGRY ORCHARD HARD CIDER  
CONGAREE & PENN  
HARD FARM CIDER  
WHITE CLAW MANGO  
HARD SELTZER  
WHITE CLAW BLACK CHERRY  
HARD SELTZER  
TRULY WILD BERRY HARD SELTZER  
HIGH NOON WATERMELON  
VODKA HARD SELTZER

## Liquor

### BOURBON & WHISKEY

*neat or rock two ounce pour*

**Manifest Rye | Jacksonville, FL**  
intense + cedar + nutty 14

**TX Blended | Fort Worth, TX**  
vanilla + butterscotch + honey butter 15

**Basil Hayden | Clermont, KY**  
cinnamon + white pepper +  
citrus peel 22

**Elijah Craig Small Batch |  
Louisville, KY**  
spice + smoke + nutmeg 16

**Bulleit Frontier | Louisville, KY**  
toffee + maple + oak + nutmeg 13

**Bulleit Rye | Louisville, KY**  
vanilla + honey + spice 13

**Ammunition Pinot Noir Finished |  
Sonoma County, CA**  
baking spices + red berries +  
hint of citrus 13

**Ammunition Cabernet Finished |  
Sonoma County, CA**  
rich caramel + butterscotch + vanilla 13

**Jack Daniel's Black |  
Lynchburg, TN**  
dark honey + oak + banana 12

**Jack Daniel's Single Barrel |  
Lynchburg, TN**  
baking spices + cocoa + leather 16

**Jack Daniel's Honey |  
Lynchburg, TN**  
mulled cider + cardamom +  
candied ginger 12

**Gentleman Jack | Lynchburg, TN**  
caramel + vanilla + charcoal 13

**Redwood Empire Pipe Dream |  
Sonoma County, CA**  
roasted pecan + vanilla +  
charred wood 12

**Redwood Empire Emerald Giant |  
Sonoma County, CA**  
honey + orange peel + cinnamon 12

**Redwood Empire Lost Monarch |  
Sonoma County, CA**  
clove + maple + pepper 12

**Redbreast 12 Yr | Midleton, Ireland**  
nuts + cream soda + ginger cake 20

**Knob Creek Rye | Clermont, KY**  
raw wood + cantaloupe + heat 16

**Knob Creek | Clermont, KY**  
oak + maple sugar + toasted nuts 16

**Crown Royal | Gimli, Canada**  
oak + sweet vanilla 16

**Jameson | Midleton, Ireland**  
cocoa + coffee + green apple 14

**Blanton's | Frankfort, KY**  
raisin + caramel + orange 79

**Buffalo Trace | Frankfort, KY**  
brown sugar + dark fruit + anise 20

**Pinhook Bourbon Resolve |  
Bardstown, KY**  
roasted peanuts + candied cinnamon +  
crème brûlée 13

**Pinhook Bourbon Resolve High Proof |  
Bardstown, KY**  
baked apricot+ vanilla+ burnt sugar 16

**Pinhook Rye Munny |  
Bardstown, KY**  
baked apple + black pepper + toffee 13

**Pinhook Rye Munny High Proof |  
Bardstown, KY**  
walnuts + dates + spiced caramel 15

**Pinhook Bourbon War 7 Year |  
Bardstown, KY**  
ginger snap + molasses + dried fig 24

---

**BOURBON & WHISKEY**

---

*neat or rock two ounce pour*

**Chicken Cock Kentucky Straight | Bardstown, KY**

caramel apple + graham cracker + vanilla wafer 18

**Chicken Cock Kentucky Straight Rye | Bardstown, KY**

spearmint + rye bread + citrus 22

**Chicken Cock Rye Island Rooster | Bardstown, KY**

maple + sugar candy + butter 59

**Chicken Cock Cotton Club 20 Year Rye | Bardstown, KY**

honey + ginger + soft vanilla 169

**Maker's 46 | Loretto, KY**

heavy oak + cinnamon + freshly baked bread 16

**Maker's Mark | Loretto, KY**

bold + vanilla + caramel + spice 13

**Woodford Rye | Shively, KY**

cedar + cassia + sorghum 17

**Woodford Reserve | Shively, KY**

dried fruit + orange + mint 16

**Woodford Reserve Wheat | Shively, KY**

hay + peach + vanilla 15

**Brenne | Cognac, France**

banana + tropical fruits + burnt caramel 17

**Angel's Envy | Louisville, KY**

vanilla + ripe fruit + maple syrup 15

**High West American Prairie | Park City, UT**

sweet corn + biscuits + honey nougat 13

**Kentucky Owl Confiscated | Bardstown, KY**

red apple + cinnamon + banana bread 29

**Kentucky Owl Batch 11 | Bardstown, KY**

apple + soft wine + vanilla tea 89

**WhistlePig PiggyBack | Shoreham, VT**

cocoa + cardamom + leather 13

**WhistlePig 10 Yr Rye | Shoreham, VT**

allspice + orange peel + anise + caramel 24

**WhistlePig Farmstock | Shoreham, VT**

oak + toffee + crème brûlée 27

**WhistlePig 15 Yr | Shoreham, VT**

leather + tobacco + baking spice 37

**WhistlePig Boss Hog | Shoreham, VT**

mulled cider + cardamom + candied gin 150

**Garrison Brothers Small Batch | Hye, TX**

caramel apple + cinnamon + baking spices 22

## Liquor

---

### SCOTCH

---

*neat or rock two ounce pour*

#### **Oban 14 Yr | Oban**

dried fig + smoky malt 29

#### **Monkey Shoulder | Dufftown**

rich + vibrant + speyside malt blend 11

#### **Lagavulin | Islay**

clove + lemon + fruitcake +  
heavy peat 32

#### **Talisker | Isle of Skye**

white pepper + brine +  
single barley malt 22

#### **The Glenlivet | Tomintoul**

heavy pineapple note + smooth  
complex malt 23

#### **Dewar's | Aberfeldy**

sultana raisin + apple +  
honey-roasted malt 17

#### **Laphroaig | Islay**

huge smoke + dark spice + lemon  
seaweedy malt 21

#### **Johnnie Walker | Kilmarnock**

**red:** cinnamon + pepper +  
young blend 12

**black:** tropical dark fruit + toffee +  
12 yr 19

**blue:** hazelnut + sherry +  
dark chocolate + elite 88

#### **Glenfiddich | Dufftown**

**12 yr:** fresh pear + subtle oak +  
single malt 17

#### **The Macallan | Craigellachie**

**12 yr:** ginger + orange + custard +  
double cask 25

**25 yr:** citrus + cinnamon + balanced  
sherry wood 595

**30 yr:** macadamia nut + black cherry +  
fine oak 795

#### **The Dalmore | Alness**

**12 yr:** cinnamon ice cream +  
roasted almonds 21

**15 yr:** bitter cherry + coal dust 38

**18 yr:** potpourri + marmalade 109

---

**TEQUILA & MEZCAL**

---

*neat or rock two ounce pour*

**Don Julio Blanco I Jalisco, Mexico**  
grassy + white pepper + menthol 17

**Don Julio Reposado I Jalisco, Mexico**  
tropical fruit + herbs + light oak 18

**Don Julio Añejo I Jalisco, Mexico**  
floral + rose + pear + cinnamon 21

**Patrón XO Cafe I Jalisco, Mexico**  
sweet + espresso + vanilla 16

**Patrón Silver I Jalisco, Mexico**  
spicy + black pepper + lavender 16

**Patrón Añejo I Jalisco, Mexico**  
sandalwood + celery + galia melon 20

**Gran Patrón Platinum I Jalisco, Mexico**  
vanilla + sweet dried fruit + oak 130

**Sauza Silver I Jalisco, Mexico**  
green apple + jasmine + citrus 11

**Herradura Silver I Jalisco, Mexico**  
raw green vegetable + coriander + pepper 12

**Herradura Reposado I Jalisco, Mexico**  
vanilla + caramel + light burn 13

**Herradura Añejo I Jalisco, Mexico**  
sweet banana + caramel + nuts 17

**Herradura Ultra Añejo I Jalisco, Mexico**  
coconut + butterscotch + butter 22

**Herradura 150th Anniversary I Jalisco, Mexico**  
almond + clove + chocolate 120

**Herradura Suprema I Jalisco, Mexico**  
honey + cherry + whiskey barrel 99

**Casamigos Blanco I Jalisco, Mexico**  
vanilla + cake batter + flowers 20

**Casamigos Reposado I Jalisco, Mexico**  
oak + black pepper + cinnamon 22

**Casamigos Añejo I Jalisco, Mexico**  
caramel + cooked agave + smoke 26

**Komos Reposado Rosa I Tequila Valley, Mexico**  
mineral + salt + lime 38

**Komos Cristalino I Tequila Valley, Mexico**  
cream soda + chocolate + vanilla 43

**Komos Extra Añejo I Tequila Valley, Mexico**  
orange peel + toasted pecan + candied ginger 139

**Milagro Añejo I Jalisco, Mexico**  
earthy + lemon + oak 13

**Cincoro Reposado I Jalisco, Mexico**  
sweet wall of vanilla + little agave 29

**Sombra Mezcal I Oaxaca, Mexico**  
tobacco + firewood + peat 12

**Dos Hombres Mezcal I Oaxaca, Mexico**  
mango + sapote + restrained smoke 18

White Wines

*Intensity*

Fruit



Tannin



Acidity



LUNETTA • **Prosecco Brut**



CHANDON • **Sparkling Rosé**



MOËT & CHANDON IMPÉRIAL • **Brut Rosé**



CHATEAU RAHOUL GRAVES • **White Bordeaux**



SANTA MARGHERITA • **Pinot Grigio**



CHATEAU D'ESCLANS WHISPERING ANGEL • **Rosé**



DECOY BY DUCKHORN • **Sauvignon Blanc**



ORIN SWIFT MANNEQUIN • **Chardonnay**



LONG MEADOW RANCH • **Chardonnay**

White Wines

|                           | 6oz | 9oz | BTL |
|---------------------------|-----|-----|-----|
| Veneto, Italy (187ml)     | -   | -   | 15  |
| California (187ml)        | -   | -   | 23  |
| Champagne, France (187ml) | -   | -   | 34  |
| Bordeaux, France          | 19  | 27  | 75  |
| Valdadige, Veneto, Italy  | 16  | 22  | 64  |
| Côtes de Provence, France | 16  | 22  | 64  |
| California                | 12  | 17  | 48  |
| California                | 19  | 27  | 75  |
| California                | 19  | 27  | 75  |

Red Wines

*Intensity*

Fruit



Tannin



Acidity



BELLE GLOS CLARK & TELEPHONE • **Pinot Noir**



BANFI • **Chianti Classico**



DUCKHORN • **Merlot**



CATENA VISTA FLORES • **Malbec**



TRIBUTE • **Cabernet Sauvignon**



J. LOHR PURE PASO • **Red Blend**



THE PRISONER UNSHACKLED  
**Cabernet Sauvignon**



DAOU • **Cabernet Sauvignon**

*Red Wines*

|                         | 6oz | 9oz | BTL |
|-------------------------|-----|-----|-----|
| California              | 23  | 32  | 80  |
| Tuscany, Italy          | 17  | 25  | 66  |
| Napa Valley, California | 29  | 42  | 116 |
| Mendoza, Argentina      | 12  | 17  | 48  |
| California              | 14  | 19  | 56  |
| California              | 16  | 22  | 64  |
| Napa Valley, California | 15  | 21  | 60  |
| Paso Robles, California | 16  | 22  | 64  |

---

BOARDS

---

**FLORIDA-GEORGIA  
CHEESE** 19

thomasville tomme +  
grateful hill farm cotton  
cloud goat cheese +  
sweet grass dairy  
green hill camembert +  
georgia peach jam +  
benne seed crackers

*n*

**LOCAL CHEESE &  
CHARCUTERIE** 32

thomasville tomme +  
grateful hill farm cotton  
cloud goat cheese +  
prosciutto +  
truffle salame +  
georgia peach jam +  
cohen farm pecans +  
house pickle +  
benne seed crackers +  
grilled sourdough

---

FLATS

---

**PROSCIUTTO  
FLATBREAD** 22

grateful hill farm cotton  
cloud goat cheese +  
green apple + arugula +  
balsamic

**CAPRESE  
FLATBREAD** 19

basil pesto +  
fresh mozzarella +  
tomato + saffron and  
onion marmalade

---

DIPS

---

*vg* **SMOKED  
EGGPLANT DIP** 16

roasted garlic +  
cardamom + lemon +  
tomato pesto +  
garden vegetables +  
grilled flatbread

*gf* **BUFFALO  
CHICKEN DIP** 18

pimento cheese +  
bacon jam +  
chipotle crema +  
green onion +  
house ranch potato chips

---

SNACKS

---

**SAND DOLLAR  
MOZZARELLA** 15

fried fresh mozzarella +  
marinara + parmesan +  
basil

*gf* **SMOKED  
STEAK FRIES** 18

smoked gouda fondue +  
nueske's bacon +  
cheddar + green onion +  
roasted garlic + gherkin

*gf* **AMELIA HOT WINGS** 18

crisp chicken wings +  
florida citrus buffalo +  
buttermilk dressing

---

HANDHELDS

---

**BEACH BBQ SLIDERS** 19

house ground beef +  
tobacco onion +  
thomasville tomme  
cheese + bacon jam +  
vidalia white bbq sauce

*n* **SOUTHERN BAO** 19

*df* pork rib + carrot slaw +  
habanero peach bbq +  
cohen farm pecans +  
citrus chili aioli +  
crispy garlic +  
steamed bun

*df* **CRAB CAKE SLIDERS** 24

florida citrus slaw +  
datil pepper aioli +  
brioche bun

Desserts & NA Beverages

---

SWEETS

**n**    **DESSERT**  
**CHARCUTERIE** 19  
strawberry + salty pretzel +  
pecan blondie +  
puffed rice bar +  
fireside brownie  
  
Get Saucy:  
chocolate + biscoff +  
marshmallow

**FLORIDA**  
**CITRUS TRIO** 12  
flourless chocolate  
orange cake +  
key lime cheesecake +  
mango mousse +  
lemon blueberry  
cream puff

---

BEVERAGES

**FLAT**

ACQUA PANNA 500ML 6

**HOT COFFEE & TEA**

COFFEE 5/6/7

HOT TEA 5/7

**FIZZ**

RED BULL ENERGY DRINK 7

RED BULL SUGARFREE 7

S.PELLEGRINO SPARKLING  
MINERAL WATER 500ML 6

S.PELLEGRINO ESSENZA  
ASSORTED 6

---

GLUTEN-FRIENDLY **gf**    DAIRY-FREE **df**    VEGAN **vg**    CONTAINS NUTS **n**

---

Gluten-friendly bread available upon request. Please notify us of any food allergy.

\*Consuming raw or undercooked meats, poultry, seafood, shellfish or eggs may increase your risk of foodborne illness.

With sincere gratitude we give thanks  
to our partners who build community  
and promote sustainability.

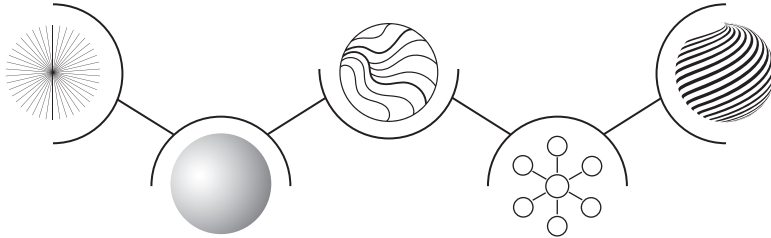



## COMMUNITY

**Owen's American Tonic:** Helping to raise awareness to Fields of Honor in support of families of fallen or disabled military and first responders with more than 35,000 scholarships awarded since 2007.

**21 Seeds Tequila:** Female-founded infused tequila inspiring you to gather your tribe of friends new and old, cross borders, share ideas, and make connections.

**Appleton Estate Rum:** In 1997, Dr. Joy Spence became the first woman appointed master blender in the industry, an amazing milestone for women across the world!

**Woodford Reserve Bourbon:** Woodford Reserve works closely with Old Friend Farms, where racing thoroughbreds are sent to retire and raise awareness of the importance of equine aftercare.

**High West Bourbon:** Pledged \$1,000,000 over the next three years to organizations that are working to protect the West from wildfires – including Wildland Firefighter Foundation, Protect Our Winters (POW), and American Prairie Reserve.

**Monin:** Honored to partner with organizations making a positive impact including Grounds for Health, Children of Restaurant Employees (CORE), and Step Up for Students.



## SUSTAINABILITY

**Patrón Tequila:** Patrón was the first distillery to install a natural gas pipeline, which acts as its main energy source and helps reduce CO2 emissions in the atmosphere.

**Absolut Vodka:** For the past four years, Absolut has been using so-called waste spirits to reduce use of liquefied propane gas (LPG) to generate energy at their Nöbbelöv distillery.

**Seedlip:** Seedlip is a 1% for the Planet member, giving 1% of global annual revenues to environmental charities dedicated to celebrating and protecting the planet.

