

ELEMENTS OF DRINK DESIGN

Much like a well-designed object, a well-crafted cocktail takes into account the contributions of each element and how they play against each other. Balance and tension, comfort and elevation, the nuances of technique and ingredient make each cocktail unique.

The Elements of a Cocktail

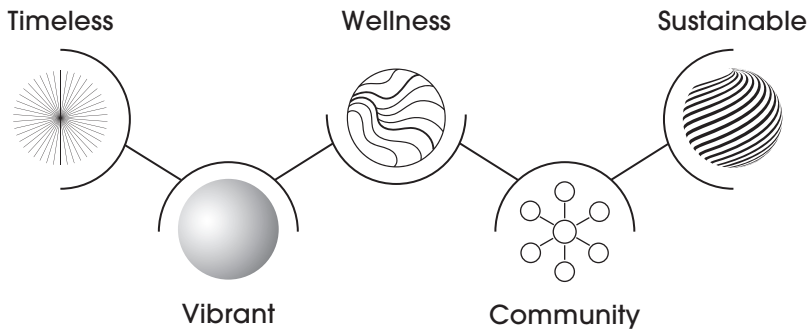



BUILD YOUR OWN HIGHBALL 16

Choose your Spirit:

VODKA

Tito's Handmade
Belvedere Organic
Grey Goose

TEQUILA

Herradura Silver
Casamigos Reposado
Milagro Añejo

BOURBON

Bulleit
Maker's Mark
Woodford Reserve

Choose your Mixer:

Q Club Soda
Owen's Rio Red Grapefruit
Owen's American Tonic
Q Ginger Ale
Owen's Ginger Beer

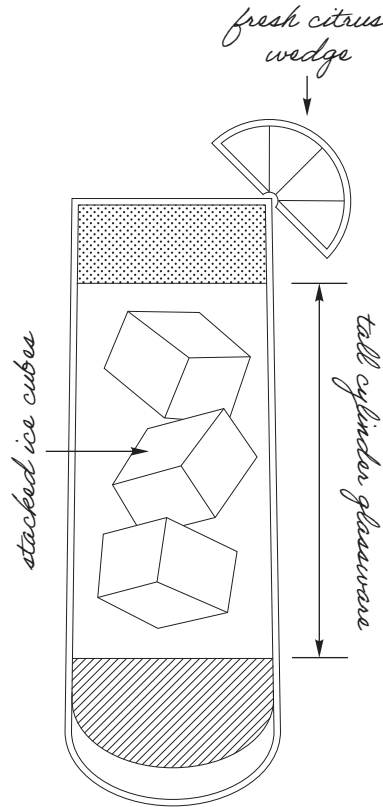

composed of an alcoholic base spirit and a larger proportion of a non-alcoholic mixer.



AMERICANO HIGHBALL 19

Campari, Antica Formula Sweet
Vermouth, Q Club Soda



OF ALL THINGS 16

21 Seeds Grapefruit Hibiscus
Tequila, Aperol, Barmalade
Grapefruit-Elderflower,
fresh lime, rhubarb bitters,
Lunetta Prosecco

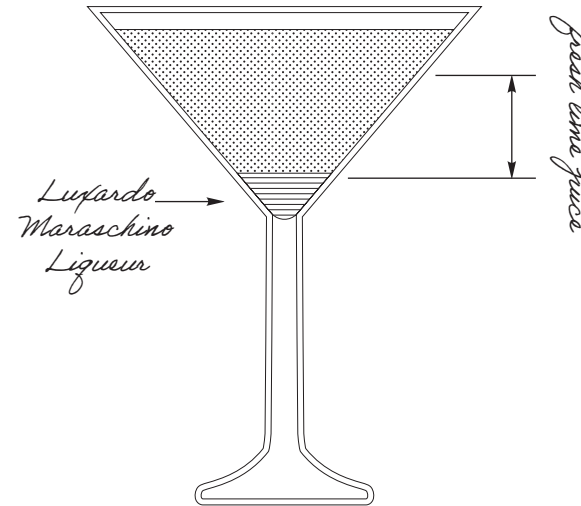

edible micro flowers

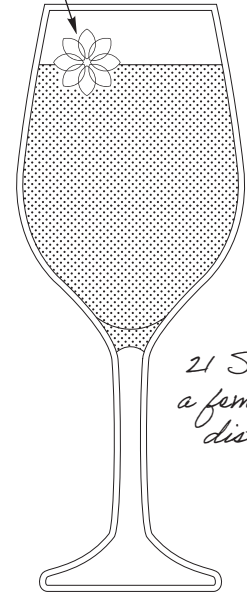

21 Seeds is a female-led distillery



THE LAST WORD MARTINI 16

Hendrick's Gin, green chartreuse,
Luxardo Maraschino Liqueur,
fresh lime

Make it smoky with Dos Hombres Mezcal 18

| ELEMENT KEY | |
|-------------|-------------|
| | Timeless |
| | Vibrant |
| | Wellness |
| | Community |
| | Sustainable |

Cocktails

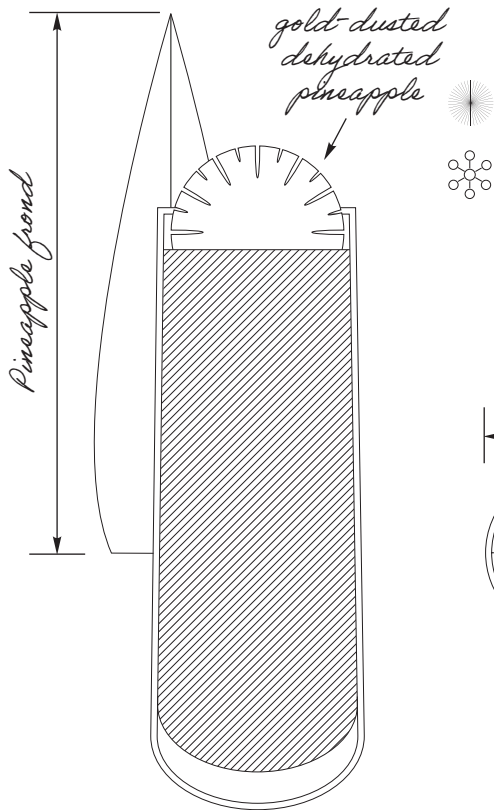

JUNGLE BIRD 16
 Appleton Estate Signature Blend Rum, Campari, Liber & Co. Pineapple Gum Syrup, fresh lime, pineapple juice

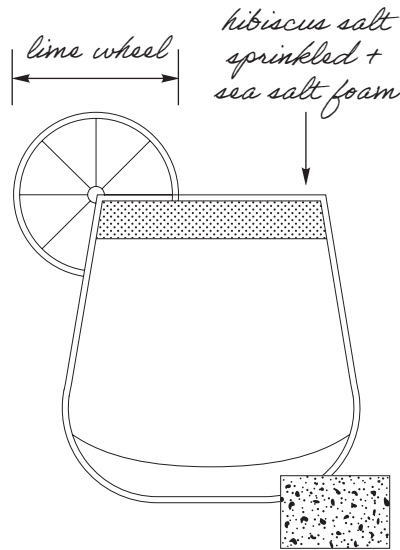

*spiced/smoked version:
 tajin rim + chili threads*

| ELEMENT KEY | |
|-------------|-------------|
| | Timeless |
| | Vibrant |
| | Wellness |
| | Community |
| | Sustainable |

MARGARITA 16
 Patrón Silver Tequila, Italicus Rosolio di Bergamotto, fresh lime, Monin Agave Nectar

Level up with Herradura Reposado 19

Make it spicy with Ancho Reyes

Chile Liqueur 18

Try it smoky with Dos Hombres Mezcal 18

Cocktails

CLASSIC MARTINI
 DRY / STIRRED 16
 The Botanist Gin or Ketel One Vodka, Carpano Dry Vermouth, orange bitters, lemon twist

DIRTY / SHAKEN 18
 Tito's Handmade Vodka, Carpano Bianco Vermouth, house brine, Filthy Foods Olive Accoutrements

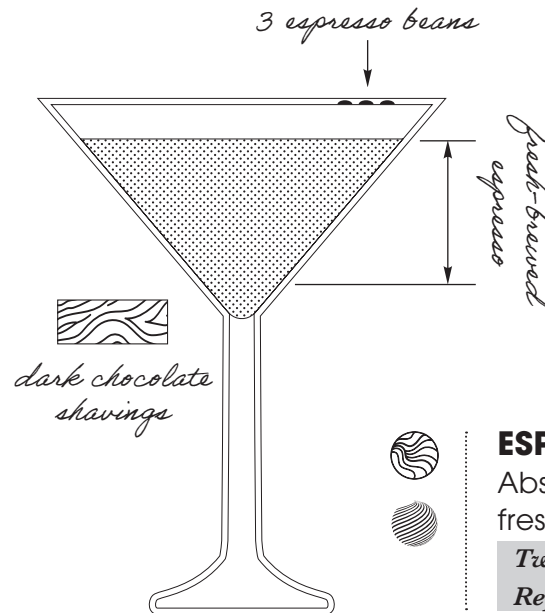
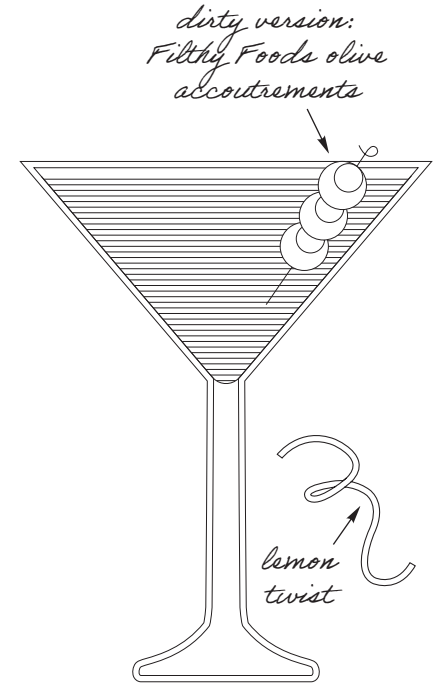

ESPRESSO MARTINI 17
 Absolut Vodka, Kahlúa, fresh espresso

Twist it up with Casamigos Reposado Tequila 19

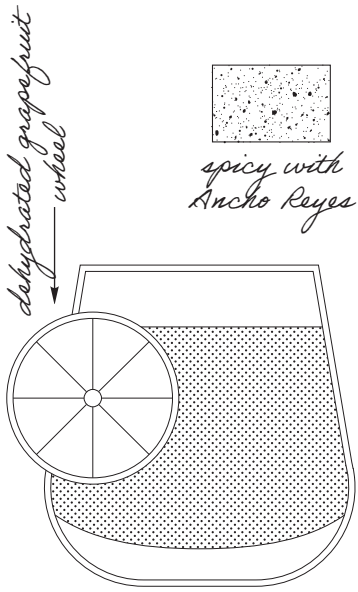

originally called the "De Rigueur" in cocktail books

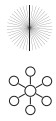

BROWN DERBY 17

Woodford Reserve Bourbon, fresh grapefruit, barrel-aged maple syrup, orange bitters

Spice it up with Ancho Reyes Chile Liqueur 19

Filthy Foods black cherry

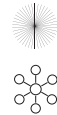
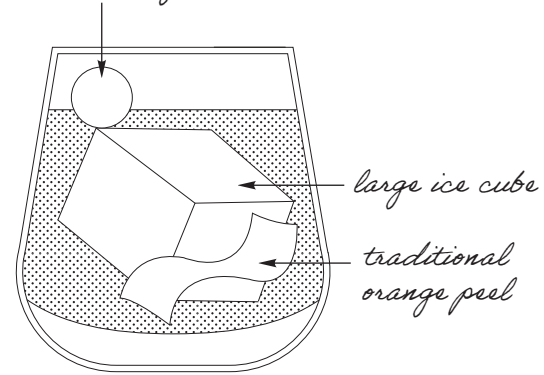

OLD FASHIONED 17

High West Bourbon, Liber & Co Demerara Syrup, El Guapo Bitters

Level up with Garrison Brothers Small Batch Bourbon 25

Make it a twist featuring Cincoro Reposado Tequila 32

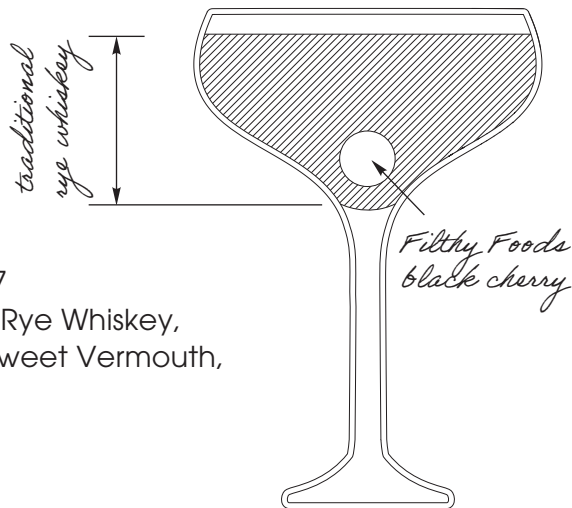

MANHATTAN 17

Knob Creek 7 Yr. Rye Whiskey, Antica Formula Sweet Vermouth, Angostura Bitters

| ELEMENT KEY | |
|-------------|-------------|
| | Timeless |
| | Vibrant |
| | Wellness |
| | Community |
| | Sustainable |

candied ginger slice

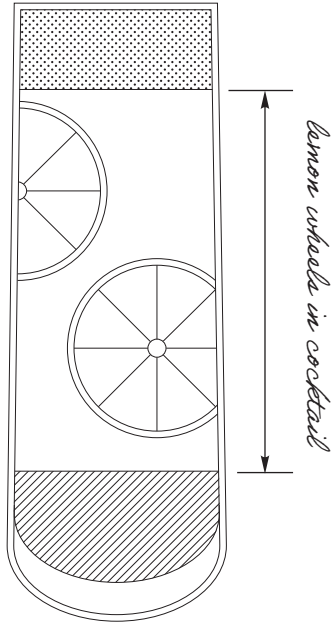

SEAMLESS 12

Monin Vanilla, Passion Fruit Reäl, fresh lemon, Q Club Soda



| ELEMENT KEY | |
|-------------|-------------|
| | Timeless |
| | Vibrant |
| | Wellness |
| | Community |
| | Sustainable |

dehydrated blood orange wheel



SILHOUETTE 12

Seedlip Grove 42, Monin Lemongrass, apple cider vinegar, orange zest

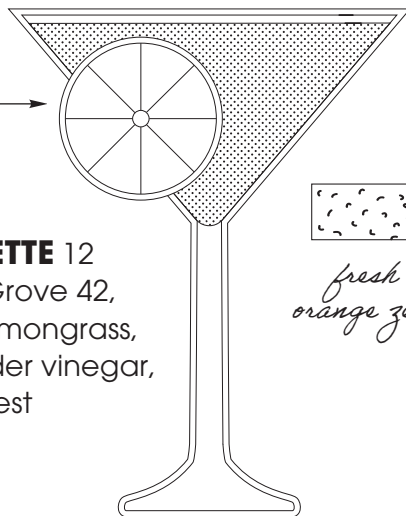

fresh orange zest

DOMESTIC 7

- MICHELOB ULTRA
- COORS LIGHT
- MILLER LITE
- BUD LIGHT
- BUDWEISER

IMPORTED 8

- CORONA EXTRA
- DOS EQUIS LAGER
- HEINEKEN
- PERONI
- STELLA ARTOIS
- GUINNESS
- MODELO ESPECIAL

NON-ALCOHOLIC 6

- HEINEKEN 0.0 NA LAGER
- ATHLETIC BREWING CO
- RUN WILD NA IPA

CRAFT 8

- SAMUEL ADAMS BOSTON LAGER
- SAMUEL ADAMS SEASONAL
- NEW BELGIUM FAT TIRE ALE
- NEW BELGIUM VODOO
- RANGER JUICY HAZE IPA
- BLUE MOON BELGIAN WHITE
- INTUITION I-10 IPA
- MOCAMA COSICO IPA
- YUENGLING AMERICAN LAGER

HARD SELTZERS

& CIDERS 8

- ANGRY ORCHARD HARD CIDER
- CONGAREE & PENN
- HARD FARM CIDER
- WHITE CLAW MANGO
- HARD SELTZER
- WHITE CLAW BLACK CHERRY
- HARD SELTZER
- TRULY WILD BERRY HARD SELTZER
- HIGH NOON WATERMELON
- VODKA HARD SELTZER

BOURBON & WHISKEY

neat or rock two ounce pour

Manifest Rye | Jacksonville, FL
intense + cedar + nutty 14

TX Blended | Fort Worth, TX
vanilla + butterscotch + honey butter 15

Basil Hayden | Clermont, KY
cinnamon + white pepper +
citrus peel 14

**Elijah Craig Small Batch |
Louisville, KY**
spice + smoke + nutmeg 11

Bulleit Frontier | Louisville, KY
toffee + maple + oak + nutmeg 13

Bulleit Rye | Louisville, KY
vanilla + honey + spice 13

**Ammunition Pinot Noir Finished |
Sonoma County, CA**
baking spices + red berries +
hint of citrus 13

**Ammunition Cabernet Finished |
Sonoma County, CA**
rich caramel + butterscotch + vanilla 13

**Jack Daniel's Black |
Lynchburg, TN**
dark honey + oak + banana 12

**Jack Daniel's Single Barrel |
Lynchburg, TN**
baking spices + cocoa + leather 16

**Jack Daniel's Honey |
Lynchburg, TN**
mulled cider + cardamom +
candied ginger 13

Gentleman Jack | Lynchburg, TN
caramel + vanilla + charcoal 12

**Redwood Empire Pipe Dream |
Sonoma County, CA**
roasted pecan + vanilla +
charred wood 12

**Redwood Empire Emerald Giant |
Sonoma County, CA**
honey + orange peel + cinnamon 12

**Redwood Empire Lost Monarch |
Sonoma County, CA**
clove + maple + pepper 12

Redbreast 12 Yr | Midleton, Ireland
nuts + cream soda + ginger cake 20

Knob Creek Rye | Clermont, KY
raw wood + cantaloupe + heat 16

Knob Creek | Clermont, KY
oak + maple sugar + toasted nuts 16

Crown Royal | Gimli, Canada
oak + sweet vanilla 16

Jameson | Middleton, Ireland
cocoa + coffee + green apple 17

Blanton's | Frankfort, KY
raisin + caramel + orange 129

Buffalo Trace | Frankfort, KY
brown sugar + dark fruit + anise 20

**Pinhook Bourbon Resolve |
Bardstown, KY**
roasted peanuts + candied cinnamon +
crème brûlée 13

**Pinhook Bourbon Resolve High Proof |
Bardstown, KY**
baked apricot+ vanilla+ burnt sugar 16

**Pinhook Rye Munny |
Bardstown, KY**
baked apple + black pepper + toffee 13

**Pinhook Rye Munny High Proof |
Bardstown, KY**
walnuts + dates + spiced caramel 15

**Pinhook Bourbon War 7 Year |
Bardstown, KY**
ginger snap + molasses + dried fig 24

BOURBON & WHISKEY

neat or rock two ounce pour

**Chicken Cock Kentucky Straight |
Bardstown, KY**
caramel apple + graham cracker +
vanilla wafer 18

**Chicken Cock Kentucky
Straight Rye | Bardstown, KY**
spearmint + rye bread + citrus 22

**Chicken Cock Rye Island Rooster |
Bardstown, KY**
maple + sugar candy + butter 59

**Chicken Cock Cotton Club 20 Year
Rye | Bardstown, KY**
honey + ginger + soft vanilla 169

Maker's 46 | Loretto, KY
heavy oak + cinnamon +
freshly baked bread 16

Maker's Mark | Loretto, KY
bold + vanilla + caramel + spice 13

Woodford Rye | Shively, KY
cedar + cassia + sorghum 17

Woodford Reserve | Shively, KY
dried fruit + orange + mint 17

**Woodford Reserve Wheat |
Shively, KY**
hay + peach + vanilla 15

Brenne | Cognac, France
banana + tropical fruits +
burnt caramel 17

Angel's Envy | Louisville, KY
vanilla + ripe fruit + maple syrup 15

**High West American Prairie |
Park City, UT**
sweet corn + biscuits +
honey nougat 13

**Kentucky Owl Confiscated |
Bardstown, KY**
red apple + cinnamon +
banana bread 29

**Kentucky Owl Batch 11 |
Bardstown, KY**
apple + soft wine + vanilla tea 89

**WhistlePig PiggyBack |
Shoreham, VT**
cocoa + cardamom + leather 13

WhistlePig 10 Yr Rye | Shoreham, VT
allspice + orange peel + anise +
caramel 24

**WhistlePig Farmstock |
Shoreham, VT**
oak + toffee + crème brûlée 27

WhistlePig 15 Yr | Shoreham, VT
leather + tobacco + baking spice 37

WhistlePig Boss Hog | Shoreham, VT
mulled cider + cardamom +
candied gin 150

**Garrison Brothers Small Batch |
Hye, TX**
caramel apple + cinnamon +
baking spices 22

Liquor

SCOTCH

neat or rock two ounce pour

Oban 14 Yr | Oban
dried fig + smoky malt 29

Monkey Shoulder | Dufftown
rich + vibrant + speyside malt blend 11

Lagavulin | Islay
clove + lemon + fruitcake +
heavy peat 32

Talisker | Isle of Skye
white pepper + brine +
single barley malt 22

The Glenlivet | Tomintoul
heavy pineapple note + smooth
complex malt 23

Dewar's | Aberfeldy
sultana raisin + apple +
honey-roasted malt 17

Laphroaig | Islay
huge smoke + dark spice + lemon
seaweedy malt 21

Johnnie Walker | Kilmarnock
red: cinnamon + pepper +
young blend 12

black: tropical dark fruit + toffee +
12 yr 19

blue: hazelnut + sherry +
dark chocolate + elite 88

Glenfiddich | Dufftown
12 yr: fresh pear + subtle oak +
single malt 17

The Macallan | Craigellachie
12 yr: ginger + orange + custard +
double cask 25

25 yr: citrus + cinnamon + balanced
sherry wood 595

30 yr: macadamia nut + black cherry +
fine oak 795

The Dalmore | Alness
12 yr: cinnamon ice cream +
roasted almonds 21

15 yr: bitter cherry + coal dust 38

18 yr: potpourri + marmalade 109

TEQUILA & MEZCAL

neat or rock two ounce pour

Don Julio Blanco | Jalisco, Mexico
grassy + white pepper + menthol 17

Don Julio Reposado | Jalisco, Mexico
tropical fruit + herbs + light oak 18

Don Julio Añejo | Jalisco, Mexico
floral + rose + pear + cinnamon 21

Patrón XO Cafe | Jalisco, Mexico
sweet + espresso + vanilla 11

Patrón Silver | Jalisco, Mexico
spicy + black pepper + lavender 16

Patrón Añejo | Jalisco, Mexico
sandalwood + celery + galia melon 18

Gran Patrón Platinum | Jalisco, Mexico
vanilla + sweet dried fruit + oak 130

Sauza Silver | Jalisco, Mexico
green apple + jasmine + citrus 11

Herradura Silver | Jalisco, Mexico
raw green vegetable + coriander +
pepper 12

Herradura Reposado | Jalisco, Mexico
vanilla + caramel + light burn 12

Herradura Añejo | Jalisco, Mexico
sweet banana + caramel + nuts 16

Herradura Ultra Añejo | Jalisco, Mexico
coconut + butterscotch + butter 19

Herradura 150th Anniversary | Jalisco, Mexico
almond + clove + chocolate 105

Herradura Suprema | Jalisco, Mexico
honey + cherry + whiskey barrel 99

Casamigos Blanco | Jalisco, Mexico
vanilla + cake batter + flowers 20

Casamigos Reposado | Jalisco, Mexico
oak + black pepper + cinnamon 22

Casamigos Añejo | Jalisco, Mexico
caramel + cooked agave + smoke 26

Komos Reposado Rosa | Tequila Valley, Mexico
mineral + salt + lime 38

Komos Cristalino | Tequila Valley, Mexico
cream soda + chocolate + vanilla 43

Komos Extra Añejo | Tequila Valley, Mexico
orange peel + toasted pecan +
candied ginger 139

Milagro Añejo | Jalisco, Mexico
earthy + lemon + oak 13

Cincoro Reposado | Jalisco, Mexico
sweet wall of vanilla + little agave 29

Sombra Mezcal | Oaxaca, Mexico
tobacco + firewood + peat 12

Dos Hombres Mezcal | Oaxaca, Mexico
mango + sapote + restrained smoke 18

Liquor

White Wines

White Wines

| <i>Intensity</i> | | | | | | | | | |
|------------------|--------|---------|--|---------------------------|--|--|-----|-----|-----|
| Fruit | Tannin | Acidity | | | | | 6oz | 9oz | BTL |
| ● | ● | ● | LUNETTA • Prosecco Brut | Veneto, Italy (187ml) | | | - | - | 15 |
| ● | ● | ● | CHANDON • Sparkling Rosé | California (187ml) | | | - | - | 23 |
| ○ | ● | ● | MOËT & CHANDON IMPÉRIAL • Brut Rosé | Champagne, France (187ml) | | | - | - | 34 |
| ● | ○ | ● | CHATEAU RAHOUL GRAVES • White Bordeaux | Bordeaux, France | | | 19 | 27 | 75 |
| ○ | ○ | ● | SANTA MARGHERITA • Pinot Grigio | Valdadige, Veneto, Italy | | | 16 | 22 | 64 |
| ○ | ● | ● | CHATEAU D'ESCLANS WHISPERING ANGEL • Rosé | Côtes de Provence, France | | | 16 | 22 | 64 |
| ● | ○ | ● | DECOY BY DUCKHORN • Sauvignon Blanc | California | | | 12 | 17 | 48 |
| ● | ○ | ● | ORIN SWIFT MANNEQUIN • Chardonnay | California | | | 19 | 27 | 75 |
| ● | ● | ○ | LONG MEADOW RANCH • Chardonnay | California | | | 19 | 27 | 75 |

○ MIN ● MID ● MAX

Red Wines

Red Wines

| <i>Intensity</i> | | | | | | | 6oz | 9oz | BTL | |
|------------------|--------|---------|---|---|---|--|-------------------------|-----|-----|-----|
| Fruit | Tannin | Acidity | | | | | | | | |
| | | | ● | ● | ○ | BELLE GLOS CLARK & TELEPHONE • Pinot Noir | California | 23 | 32 | 80 |
| ○ | ● | ● | ○ | ● | ● | BANFI • Chianti Classico | Tuscany, Italy | 17 | 25 | 66 |
| ● | ● | ● | ● | ● | ● | DUCKHORN • Merlot | Napa Valley, California | 29 | 42 | 116 |
| ○ | ● | ● | ○ | ● | ● | CATENA VISTA FLORES • Malbec | Mendoza, Argentina | 12 | 17 | 48 |
| ● | ● | ● | ● | ● | ● | TRIBUTE • Cabernet Sauvignon | California | 14 | 19 | 56 |
| ● | ● | ● | ● | ● | ● | J. LOHR PURE PASO • Red Blend | California | 16 | 22 | 64 |
| ● | ● | ● | ● | ● | ● | THE PRISONER UNSHACKLED Cabernet Sauvignon | Napa Valley, California | 15 | 21 | 60 |
| ● | ● | ● | ● | ● | ● | DAOU • Cabernet Sauvignon | Paso Robles, California | 16 | 22 | 64 |

○ MIN ● MID ● MAX

BOARDS

 **FLORIDA-GEORGIA CHEESE** 19
thomasville tomme + grateful hill farm cotton cloud goat cheese + sweet grass dairy green hill camembert + georgia peach jam + benne seed crackers

LOCAL CHEESE & CHARCUTERIE 32
thomasville tomme + grateful hill farm cotton cloud goat cheese + prosciutto + bresaola + georgia peach jam + cohen farm pecans + house pickle + benne seed crackers + grilled sourdough

DIPS

 **SMOKED EGGPLANT DIP** 16
roasted garlic + cardamom + lemon + tomato pesto + garden vegetables + grilled flatbread

 **BUFFALO CHICKEN DIP** 18
pimento cheese + bacon jam + chipotle crema + green onion + house ranch potato chips

SNACKS

 **TRUFFLE PARMESAN FRIES** 16
rosemary + truffle aioli



 **CRISPY GATOR BITES** 19
green tomato relish + arugula + cajun remoulade

 **CRAB CAKE SLIDERS** 24
florida citrus slaw + datil pepper aioli + brioche bun

 **AMELIA HOT WINGS** 18
crisp chicken wings + florida citrus buffalo + buttermilk dressing

 **SAND DOLLAR MOZZARELLA** 15
fried fresh mozzarella + marinara + parmesan + basil

SWEETS

 **TRIPLE CHOCOLATE FLOURLESS CAKE** 12
 chocolate mousse + white chocolate chantilly + salted caramel

 **DREAMSICLE BRÛLÉE CHEESECAKE** 12
citrus cheesecake + vanilla bean chantilly + orange gel

LARGE PLATES

**GRANNY APPLE
BURGER* 22**

twin patties + thomasville
tomme cheese
apple-wood smoked
bacon + granny smith
apple butter + arugula +
house pickle +
potato roll

**CLASSIC HOUSE
GRIND BURGER 19**

twin patties + lettuce +
tomato + red onion +
house pickle +
potato roll

**GRILLED CHICKEN
SANDWICH 18**

grilled chicken breast +
cheddar + applewood-
smoked bacon +
lettuce + tomato +
buttermilk dressing +
potato roll

**PROSCIUTTO
FLATBREAD 22**

grateful hill farm cotton
cloud goat cheese +
green apple + arugula +
balsamic



**CAPRESE
FLATBREAD 19**

basil pesto + fresh
mozzarella + tomato +
saffron & onion
marmalade

**SMOKED GOUDA
MAC & CHEESE 22**

tasso ham + roasted
poblano + tobacco onion
add: grilled chicken 10
add: local shrimp 13

HOT COFFEE & TEA

COFFEE 5/6/7
HOT TEA 5/7
CHAI TEA LATTE 5.75/6.75/7.75
ESPRESSO 5/7
MACCHIATO 6.5/7.5/8.5
CAPPUCCINO 5.75/6.75/7.75
AMERICANO 5.5/6.5/7.5
CORTADO 5/7
LATTE MACCHIATO 6.5/7.5/8.5

ICED COFFEE & TEA

NITRO 6.5/7.5/8.5
LATTE 6/7/8
MACCHIATO 6.75/7.75/8.75
MOCHA 6.75/7.75/8.75
CHAI TEA LATTE 6/7/8

JUICE

FRESH-SQUEEZED
ORANGE JUICE 9

FIZZ

RED BULL ENERGY DRINK 7
RED BULL SUGARFREE 7
S.PELLEGRINO SPARKLING
MINERAL WATER 500ML 6
S.PELLEGRINO ESSENZA
ASSORTED 6

FLAT

ACQUA PANNA 500ML 6

GLUTEN-FRIENDLY DAIRY-FREE VEGAN VEGETARIAN

Gluten-friendly bread available upon request. Please notify us of any food allergy.

*Consuming raw or undercooked meats, poultry, seafood, shellfish or eggs may increase your risk of foodborne illness.

With sincere gratitude we give thanks
to our partners who build community
and promote sustainability.

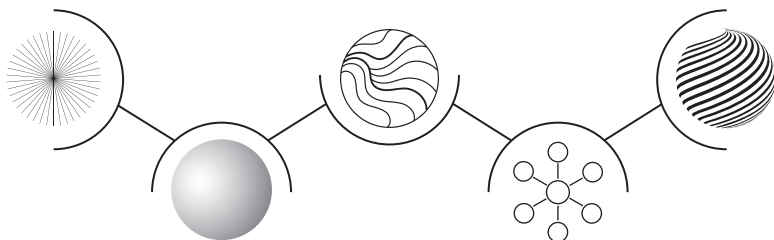

COMMUNITY

Owen's American Tonic: Helping to raise awareness to Fields of Honor in support of families of fallen or disabled military and first responders with more than 35,000 scholarships awarded since 2007.

21 Seeds Tequila: Female-founded infused tequila inspiring you to gather your tribe of friends new and old, cross borders, share ideas, and make connections.

Appleton Estate Rum: In 1997, Dr. Joy Spence became the first woman appointed master blender in the industry, an amazing milestone for women across the world!

Woodford Reserve Bourbon: Woodford Reserve works closely with Old Friend Farms, where racing thoroughbreds are sent to retire and raise awareness of the importance of equine aftercare.

High West Bourbon: Pledged \$1,000,000 over the next three years to organizations that are working to protect the West from wildfires – including Wildland Firefighter Foundation, Protect Our Winters (POW), and American Prairie Reserve.

Monin: Honored to partner with organizations making a positive impact including Grounds for Health, Children of Restaurant Employees (CORE), and Step Up for Students.



SUSTAINABILITY

Patrón Tequila: Patrón was the first distillery to install a natural gas pipeline, which acts as its main energy source and helps reduce CO2 emissions in the atmosphere.

Absolut Vodka: For the past four years, Absolut has been using so-called waste spirits to reduce use of liquefied propane gas (LPG) to generate energy at their Nöbbelöv distillery.

Seedlip: Seedlip is a 1% for the Planet member, giving 1% of global annual revenues to environmental charities dedicated to celebrating and protecting the planet.