

ELEMENTS OF DRINK DESIGN

Much like a well-designed object, a well-crafted cocktail takes into account the contributions of each element and how they play against each other. Balance and tension, comfort and elevation, the nuances of technique and ingredient make each cocktail unique.

The Elements of a Cocktail

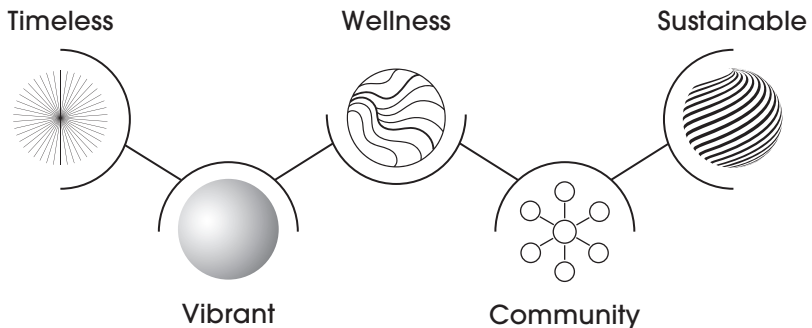



BUILD YOUR OWN HIGHBALL 16

Choose your Spirit:

VODKA

- Tito's Handmade
- Belvedere Organic
- Grey Goose

TEQUILA

- Herradura Silver
- Casamigos Reposado
- Milagro Añejo

BOURBON

- Bulleit
- Maker's Mark
- Woodford Reserve

Choose your Mixer:

- Q Club Soda
- Owen's Rio Red Grapefruit
- Owen's American Tonic
- Q Ginger Ale
- Owen's Ginger Beer

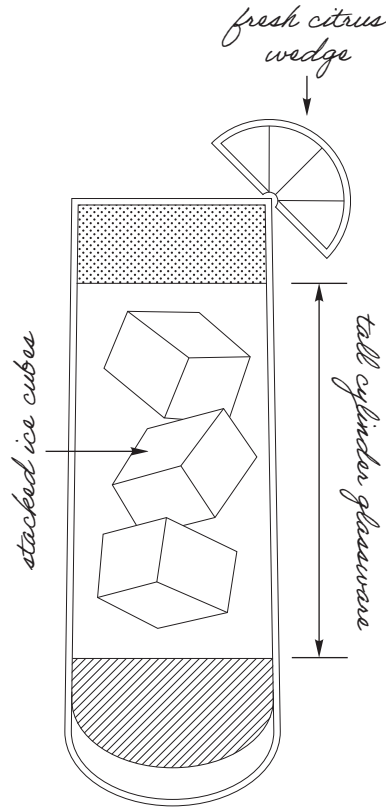

composed of an alcoholic base spirit and a larger proportion of a non-alcoholic mixer.



AMERICANO HIGHBALL 17

- Campari, Antica Formula Sweet
- Vermouth, Q Club Soda

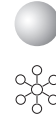

OF ALL THINGS 16

- 21 Seeds Grapefruit Hibiscus
- Tequila, Aperol, Barmalade
- Grapefruit-Elderflower,
- fresh lime, rhubarb bitters,
- Lunetta Prosecco

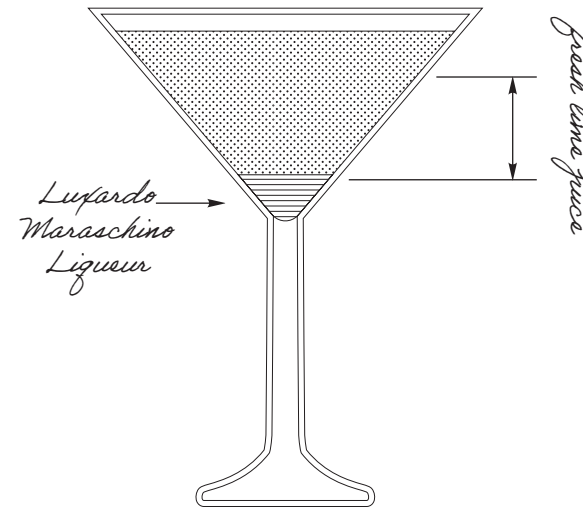

edible micro flowers

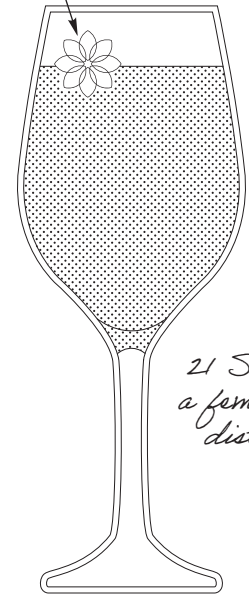

21 Seeds is a female-led distillery



THE LAST WORD MARTINI 16

- Hendrick's Gin, green chartreuse,
- Luxardo Maraschino Liqueur,
- fresh lime

Make it smoky with Dos Hombres Mezcal 18

ELEMENT KEY	
	Timeless
	Vibrant
	Wellness
	Community
	Sustainable

Cocktails

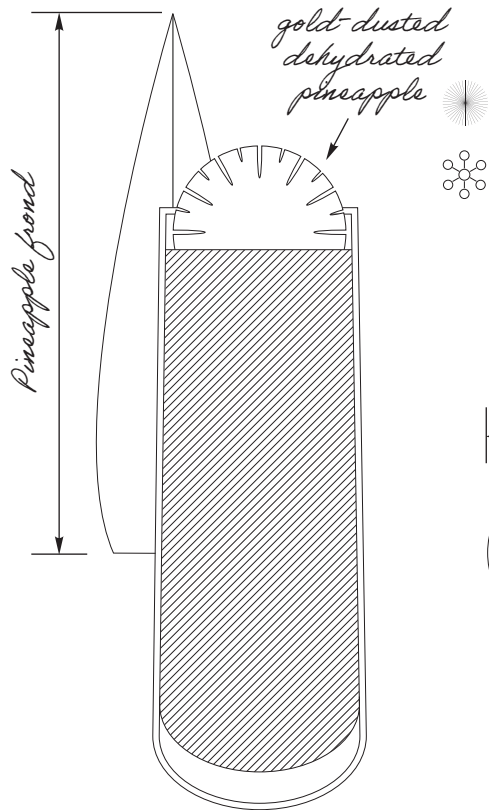

JUNGLE BIRD 16
 Appleton Estate Signature Blend Rum, Campari, Liber & Co. Pineapple Gum Syrup, fresh lime, pineapple juice

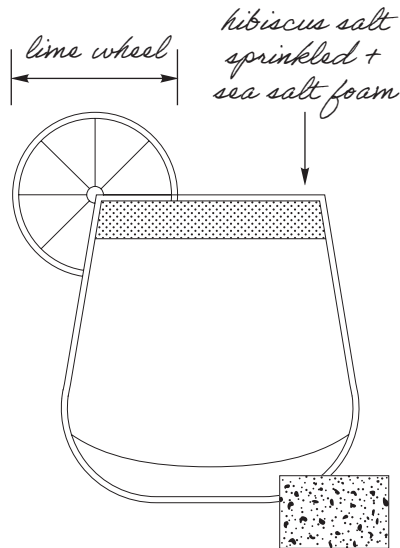

spiced/smoked version: tajin rim + chili threads

ELEMENT KEY	
	Timeless
	Vibrant
	Wellness
	Community
	Sustainable

MARGARITA 16
 Patrón Silver Tequila, Italicus Rosolio di Bergamotto, fresh lime, Monin Agave Nectar

Level up with Herradura Reposado 18

Make it spicy with Ancho Reyes Chile Liqueur 18

Try it smoky with Dos Hombres Mezcal 18

Cocktails

CLASSIC MARTINI

DRY / STIRRED 17

The Botanist Gin or Ketel One Vodka, Carpano Dry Vermouth, orange bitters, lemon twist

DIRTY / SHAKEN 17

Tito's Handmade Vodka, Carpano Bianco Vermouth, house brine, Filthy Foods Olive Accoutrements

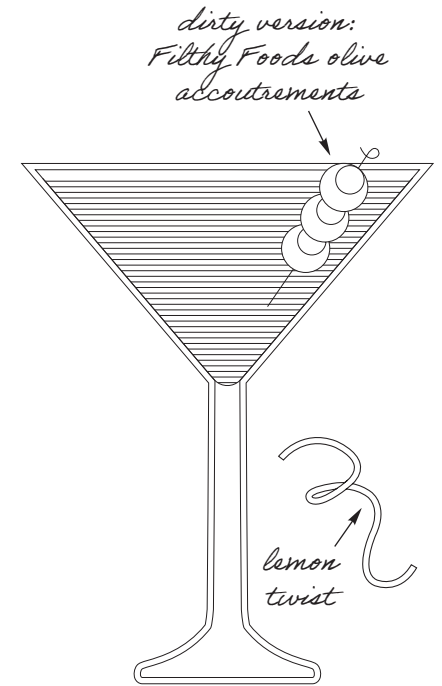

ESPRESSO MARTINI 18

Absolut Vodka, Kahlúa, fresh espresso

Twist it up with Casamigos Reposado Tequila 22

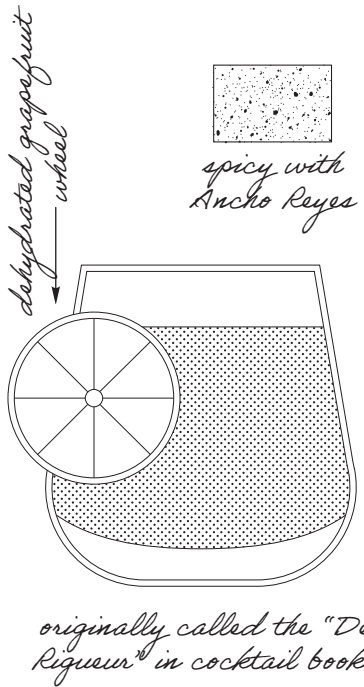

BROWN DERBY 16
 Woodford Reserve Bourbon, fresh grapefruit, barrel-aged maple syrup, orange bitters

Spice it up with Ancho Reyes Chile Liqueur 18

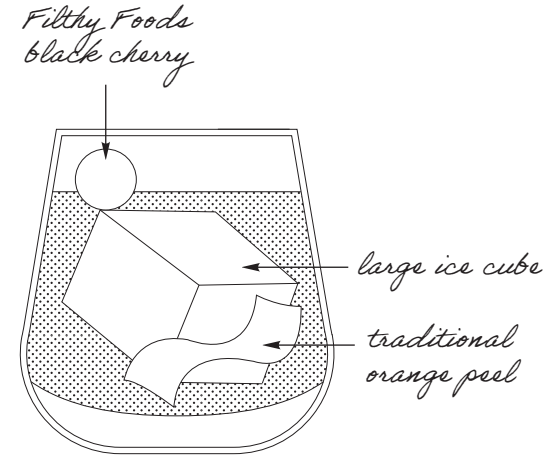

OLD FASHIONED 16
 High West Bourbon, Liber & Co Demerara Syrup, El Guapo Bitters

Level up with Garrison Brothers Small Batch Bourbon 24

Make it a twist featuring Cincoro Reposado Tequila 30



MANHATTAN 18
 Knob Creek 7 Yr. Rye Whiskey, Antica Formula Sweet Vermouth, Angostura Bitters

ELEMENT KEY	
	Timeless
	Vibrant
	Wellness
	Community
	Sustainable

candied ginger slice

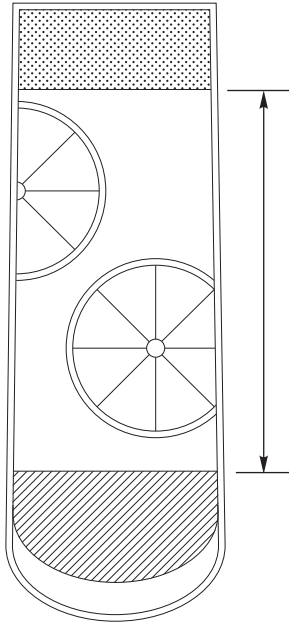

lemon wheels in cocktail



SEAMLESS 12

Monin Vanilla, Passion Fruit Reäl, fresh lemon, Q Club Soda

DOMESTIC 7

MICHELOB ULTRA
COORS LIGHT
MILLER LITE
BUD LIGHT
BUDWEISER

IMPORTED 9

CORONA EXTRA
DOS EQUIS LAGER
HEINEKEN
PERONI
STELLA ARTOIS
GUINNESS
MODELO ESPECIAL

NON-ALCOHOLIC 8

HEINEKEN 0.0 NA LAGER
ATHLETIC BREWING CO
RUN WILD NA IPA

CRAFT 9

NIGHT SHIFT NITE LITE LAGER
SAMUEL ADAMS
WICKED EASY SESSION IPA
SAMUEL ADAMS SEASONAL
BLUE MOON BELGIAN WHITE
NIGHT SHIFT WHIRLPOOL PALE ALE
NEW BELGIUM VODOO
RANGER JUICY HAZE IPA
SAMUEL ADAMS WICKED HAZY IPA
HARPOON IPA

HARD SELTZERS & CIDERS

ANGRY ORCHARD
HARD CIDER 8
ARTIFACT CIDER PROJECT 9
WHITE CLAW MANGO
HARD SELTZER 8
WHITE CLAW BLACK
CHERRY HARD SELTZER 8
TRULY WILD BERRY
HARD SELTZER 8
HIGH NOON WATERMELON
VODKA HARD SELTZER 8

dehydrated blood orange wheel

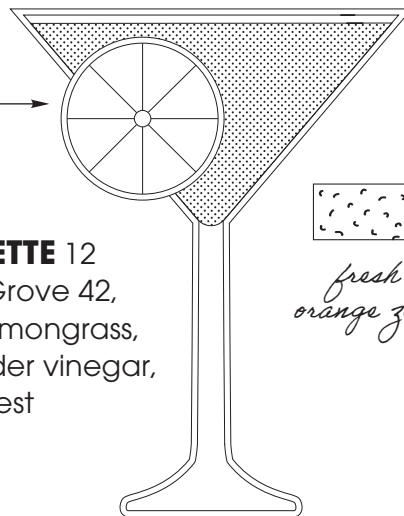

fresh orange zest



SILHOUETTE 12



Seedlip Grove 42, Monin Lemongrass, apple cider vinegar, orange zest

ELEMENT KEY	
	Timeless
	Vibrant
	Wellness
	Community
	Sustainable

White Wines

White Wines

Intensity

Fruit 	Tannin 	Acidity 			6oz	9oz	BTL
●	●	●	LUNETTA • Prosecco Brut	Veneto, Italy (187ml)	-	-	11
●	●	●	CHANDON • Sparkling Rosé	California (187ml)	-	-	18
○	●	●	MOËT & CHANDON IMPÉRIAL • Brut Rosé	Champagne, France (187ml)	-	-	35
○	●	●	VEUVE CLICQUOT YELLOW LABEL • Brut	Champagne, France	39	-	150
●	○	●	CHATEAU STE. MICHELLE • Riesling	Columbia Valley, Washington	11	15	44
○	○	●	ZENATO • Pinot Grigio	delle Venezie, Italy	12	17	48
○	○	●	SANTA MARGHERITA • Pinot Grigio	Valdadige, Veneto, Italy	20	28	78
○	●	●	CHÂTEAU D'ESCLANS WHISPERING ANGEL • Rosé	Côtes de Provence, France	17	24	66
●	○	●	J. LOHR FLUME CROSSING • Sauvignon Blanc (On Tap)	Arroyo Seco, California	13	18	-
●	○	●	DECOY BY DUCKHORN • Sauvignon Blanc	Sonoma, California	17	24	66
●	○	●	PINE RIDGE • Chenin Blanc/Viognier (On Tap)	California	11	15	-
●	●	○	WENTE RIVA RANCH • Chardonnay (On Tap)	Arroyo Seco & Monterey, California	14	19	-

○ MIN ● MID ● MAX

Red Wines

Red Wines

<i>Intensity</i>										
Fruit	Tannin	Acidity						6oz	9oz	BTL
			ELOUAN • Pinot Noir <i>(On Tap)</i>	Oregon				16	23	-
			BELLE GLOS BALADE • Pinot Noir	Santa Barbara County, California				23	32	88
			DECOY BY DUCKHORN • Merlot	Sonoma, California				18	26	70
			TRIBUTE • Cabernet Sauvignon	California				12	17	48
			CHARLES & CHARLES Cabernet Sauvignon/Syrah <i>(On Tap)</i>	Columbia Valley, Washington				14	20	-
			JOEL GOTT 815 • CABERNET SAUVIGNON <i>(On Tap)</i>	California				16	23	-
			LUIGI BOSCA DE SANGRE DOC • Malbec	Mendoza, Argentina				20	28	78
			J. LOHR PURE PASO • Red Blend	Paso Robles, California				20	28	78
			THE PRISONER WINE COMPANY UNSHACKLED • Cabernet Sauvignon	California				20	28	78

○ MIN ◐ MID ● MAX

TEQUILA

- CASAMIGOS BLANCO 15
- CASAMIGOS REPOSADO 17
- CASAMIGOS AÑEJO 19
- CIERTO PRIVATE
COLLECTION AÑEJO 42
- CINCORO BLANCO 24
- CINCORO REPOSADO 30
- CINCORO AÑEJO 36
- CLASE AZUL REPOSADO 42
- DON JULIO 1942 AÑEJO 48
- PATRÓN SILVER 15
- PÄTSCH REPOSADO 26

BOURBON & WHISKEY

- ANGEL'S ENVY BOURBON 17
- BASIL HAYDEN BOURBON 17
- BLANTON'S BOURBON 35
- EAGLE RARE 10 YR BOURBON 15
- GARRISON BROTHERS SMALL
BATCH BOURBON 22
- GENTLEMAN JACK WHISKEY 15
- HIGH WEST DOUBLE RYE 15
- KNOB CREEK RYE 15
- WHISTLEPIG 10YR
SINGLE BARREL RYE 25
- WOODFORD RESERVE
BOURBON 15

HOT COFFEE & TEA

- STANCE COFFEE 5
- NUMI HOT TEA 5
- ESPRESSO 5
- MACCHIATO 6
- CAPPUCCINO 6
- AMERICANO 5

FIZZ

- RED BULL ENERGY DRINK 6
- RED BULL SUGARFREE 6
- S.PELLEGRINO SPARKLING
MINERAL WATER 500ML 5
- S.PELLEGRINO ESSENZA
ASSORTED 6

FLAT

- ACQUA PANNA 500ML 5

VIEW MENU

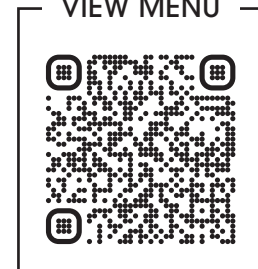

18% service charge will be added
all parties of 6 or more.

With sincere gratitude we give thanks to our partners who build community and promote sustainability.

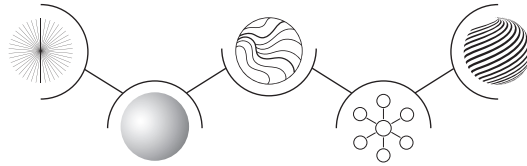

COMMUNITY

Owen's American Tonic: Helping to raise awareness to Fields of Honor in support of families of fallen or disabled military and first responders with more than 35,000 scholarships awarded since 2007.

21 Seeds Tequila: Female-founded infused tequila inspiring you to gather your tribe of friends new and old, cross borders, share ideas, and make connections.

Appleton Estate Rum: In 1997, Dr. Joy Spence became the first woman appointed master blender in the industry, an amazing milestone for women across the world!

Woodford Reserve Bourbon: Woodford works closely with Old Friend Farms, where racing thoroughbreds are sent to retire and raise awareness of the importance of equine aftercare.

High West Bourbon: Pledged \$1,000,000 over the next three years to organizations that are working to protect the West from wildfires – including “Wildland Firefighter Foundation”, “Protect Our Winters” (POW), and “American Prairie Reserve”.

Monin: Honored to partner with organizations making a positive impact including Grounds for Health, Children of Restaurant Employees (CORE), and Step Up for Students.



SUSTAINABILITY

Patrón Tequila: Patrón was the first distillery to install a natural gas pipeline, which acts as its main energy source and helps reduce CO2 emissions in the atmosphere.

Absolut Vodka: For the past four years, Absolut has been using so-called waste spirits to reduce use of liquefied propane gas (LPG) to generate energy at their Nöbbelöv distillery.

Seedlip: Seedlip is a 1% for the Planet member, giving 1% of global annual revenues to environmental charities dedicated to celebrating and protecting the planet.