

ELEMENTS OF DRINK DESIGN

Much like a well-designed object, a well-crafted cocktail takes into account the contributions of each element and how they play against each other. Balance and tension, comfort and elevation, the nuances of technique and ingredient make each cocktail unique.

The Elements of a Cocktail

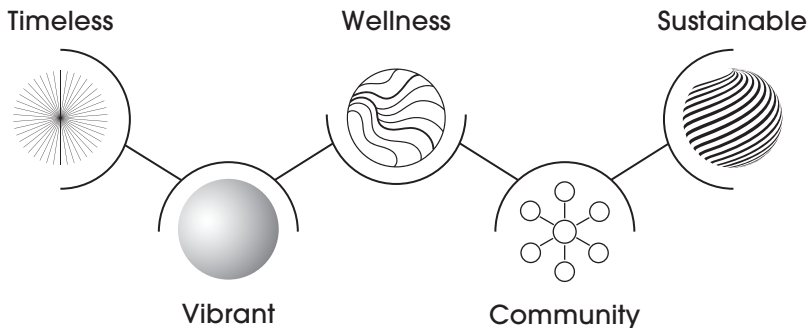



BUILD YOUR OWN HIGHBALL

Choose your Spirit:

- VODKA 1oz/2oz
- Tito's Handmade 14/25
- Belvedere Organic 14/25
- Grey Goose 14/25
- True Theory 12/19

TEQUILA 1oz/2oz

- Patrón Silver 18/33
- Don Julio Reposado 19/35
- Casamigos Añejo 21/39

BOURBON 1oz/2oz

- Bulleit 16/29
- Maker's Mark 19/35
- Buffalo Trace 16/29

Choose your Mixer:

- Fever-Tree Soda
- Fever-Tree Tonic
- Fever-Tree Ginger Ale
- Fever-Tree Ginger Beer

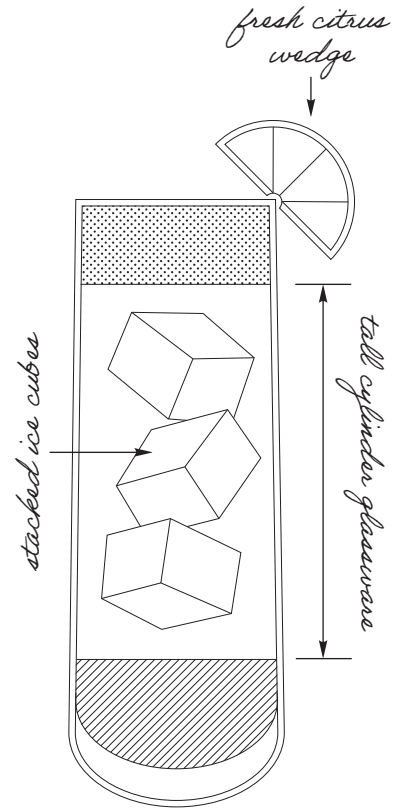

composed of an alcoholic base spirit and a larger proportion of a non-alcoholic mixer.



THE 2ND LAST WORD MARTINI 24 (2 oz.)

Hendrick's Gin, Galliano, Luxardo Maraschino Liqueur, fresh lime

Make it smoky with Leyenda Tlacuache Organic Mezcal • add 11 (½ oz.)

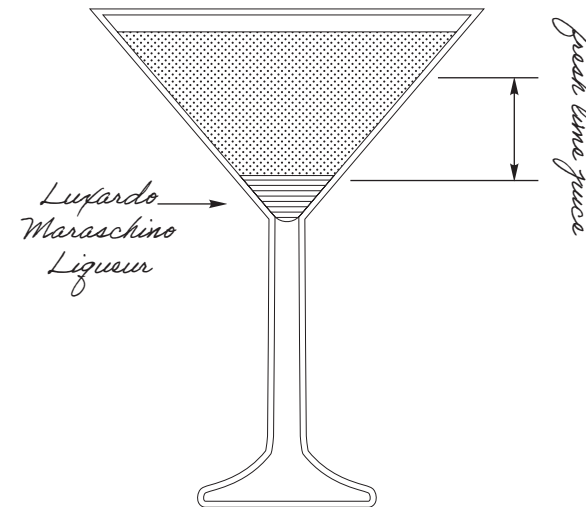

AMERICANO HIGHBALL 22 (2 oz.)

Campari, Martini Sweet Vermouth, Fever-Tree Soda

ELEMENT KEY	
	Timeless
	Vibrant
	Wellness
	Community
	Sustainable

Cocktails

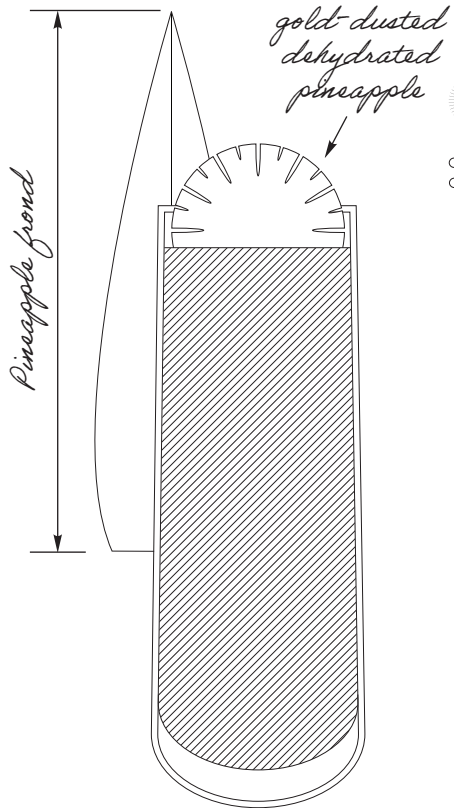

JUNGLE BIRD 23 (2 oz.)
 Appleton Estate Signature Blend Rum, Campari, Giffard Gum Syrup, fresh lime, pineapple juice

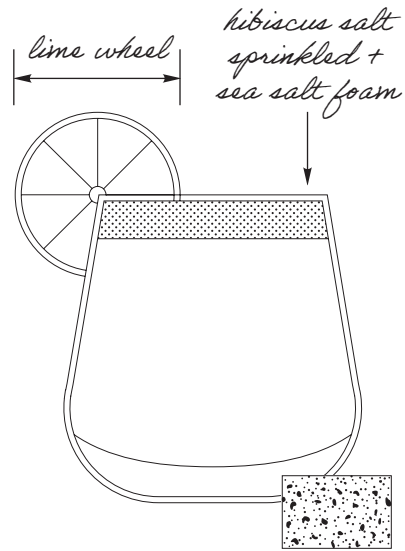
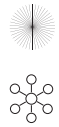

spiced/smoked version: tajin rim + chili threads

MARGARITA 23 (1.5 oz.)
 Patrón Silver Tequila, fresh lime, Giffard Agave Syrup

Leyenda Tlacuache
Organic Mezcal • add 11 (½ oz.)



ELEMENT KEY	
	Timeless
	Vibrant
	Wellness
	Community
	Sustainable

Cocktails



CLASSIC MARTINI (2.5 oz.)

DRY / STIRRED 24
 Gray Whale Gin or Ketel One Vodka, Martini Dry Vermouth, orange bitters, lemon twist

DIRTY / SHAKEN 24
 Tito's Handmade Vodka, Martini Bianco Vermouth, house brine, olive accoutrements



fresh-brewed espresso

ESPRESSO MARTINI 25 (2 oz.)
 True Theory Vodka, Kahlúa, fresh espresso

Twist it up with Don Julio Reposado Tequila • add 9 (½ oz.)



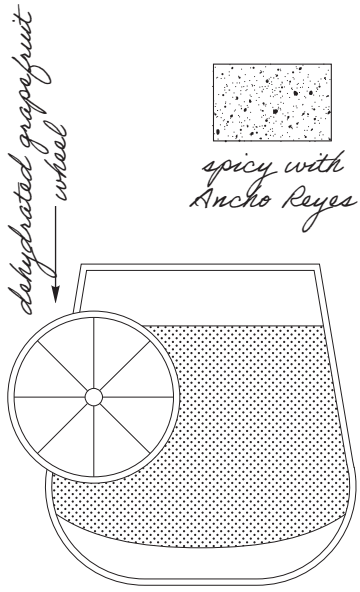

originally called the "De Rigueur" in cocktail books

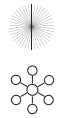

BROWN DERBY 22 (1 oz.)
Woodford Reserve Bourbon,
fresh grapefruit, barrel-aged
maple syrup, orange bitters

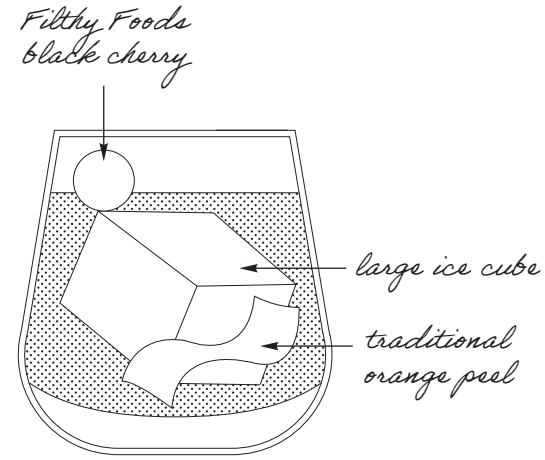





SPICED OLD FASHIONED 24 (2 oz.)
Maker's Mark Bourbon, orange bitters,
cardamom bitters, cane sugar, orange
& lemon peel

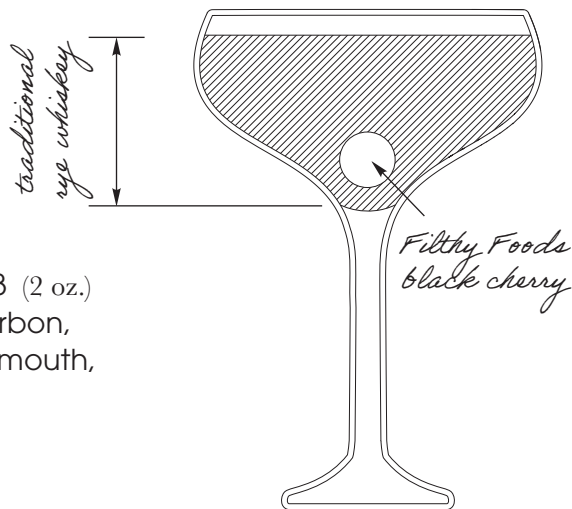

MANHATTAN 23 (2 oz.)
Bulleit Rye or Bourbon,
Martini Rosso Vermouth,
Angostura Bitters



ELEMENT KEY	
	Timeless
	Vibrant
	Wellness
	Community
	Sustainable

candied ginger slice

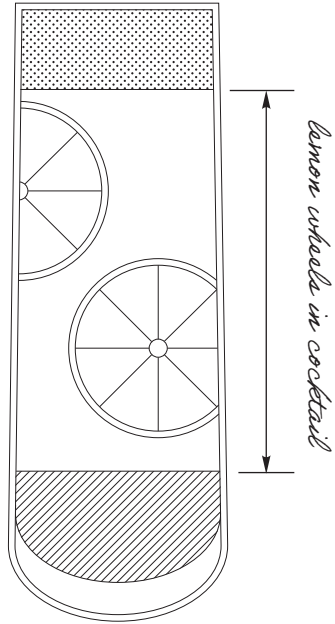

SEAMLESS 17

Passion Fruit Reàl, fresh lemon, Giffard Vanilla, Fever-Tree Soda



DOMESTIC 9

COORS LIGHT
MILL STREET ORGANIC LAGER
STEAM WHISTLE PILSNER

IMPORTED 11

CORONA EXTRA
HEINEKEN
PERONI
MICHELOB ULTRA

NON-ALCOHOLIC 8

PERONI NASTRO AZZURRO
0.0 LAGER

CRAFT 11

ON THE HUNT
ITALIAN PILSNER 473ML
BLUE MOON
BELGIAN WHITE ALE 473ML
COLLECTIVE ARTS
IPA 473ML
COLLECTIVE ARTS
LAGER 473ML
LI'L HEATHENS
HAZY IPA 473ML

HARD SELTZER

& CIDER 11
ANGRY ORCHARD
HARD CIDER 473ML
SUPERSONIC
PUPPY DREAMS SELTZER 473ML
LOCAL PRESS
APPLE CIDER 473ML
YUZU CIDER 473ML

ELEMENT KEY

	Timeless
	Vibrant
	Wellness
	Community
	Sustainable

dehydrated blood orange wheel

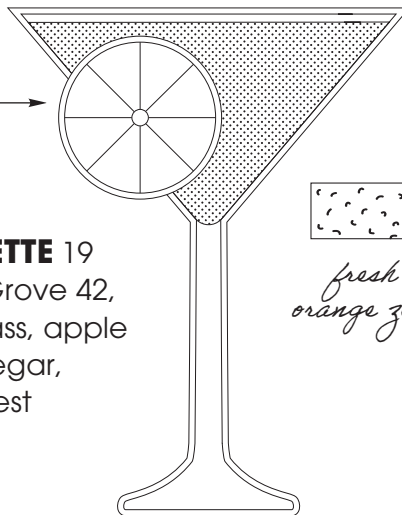

SILHOUETTE 19

Seedlip Grove 42, lemongrass, apple cider vinegar, orange zest



fresh orange zest

PLEASE ASK YOUR SERVER FOR SEASONAL SELECTION ON TAP (16oz)

SEASONAL 12

IMPORTED 13

White Wines

White Wines

Intensity

Fruit	Tannin	Acidity			6oz	9oz	BTL
●	○	◐	TOMBACCO PECORINO • White Blend	Italy	17	23	68
○	○	●	GABBIANO CAVALIERE D'ORO • Pinot Grigio	Italy	19	25	71
○	○	●	ALOIS LAGEDER • Pinot Grigio	Italy	23	29	90
◐	◐	●	GÉRARD BERTRAND COTE DES ROSES • Rosé	France	19	25	71
◐	○	●	DECOY BY DUCKHORN • Sauvignon Blanc	California	26	32	119
◐	○	●	DOMAINE DE L'HERRÉ • Sauvignon Blanc	France	18	24	68
●	○	●	SWARTLAND • Chenin Blanc	South Africa	18	24	68
●	◐	○	FRANCIS COPPOLA • Chardonnay	California	20	26	80
●	◐	○	REIF ESTATE • Chardonnay	Canada	16	22	52
●	◐	○	JEAN-MARC BROCARD • Chablis	France	26	32	119

○ MIN ◐ MID ● MAX

Red Wines

Red Wines

<i>Intensity</i>									
Fruit	Tannin	Acidity					6oz	9oz	BTL
●	○	◐	MEIOMI • Pinot Noir	California			21	28	88
○	●	●	PIANTAFERRO • Chianti DOCG	Italy			18	24	63
◐	●	○	WENTE SANDSTONE • Merlot	California			20	27	84
○	◐	◐	CANCILLER • Malbec Reserva	Argentina			17	23	69
◐	●	◐	CHÂTEAUNEUF-DU-PAPE • Les Hauts de Barville	France			29	35	110
◐	●	◐	BURBERO • Red Blend	Italy			21	28	84
◐	●	◐	CÔTES DU RHÔNE VILLAGES • Red Blend	France			21	28	84
◐	●	◐	REIF ESTATE • Cabernet Sauvignon	Canada			16	22	52
◐	●	◐	FRANCIS COPPOLA • Cabernet Sauvignon	California			20	26	80
◐	●	◐	CRANSWICK LAKEFIELD • Shiraz	Australia			18	24	71

○ MIN ◐ MID ● MAX

Spirits

VODKA 1oz / 2oz

KETEL ONE 14/25
GREY GOOSE 14/25
TITO'S HANDMADE 14/25
BELVEDERE 14/25
STOLI 12/19
SKYY 12/19
LAZULI 13/20

TEQUILA MEZCAL 1oz / 2oz

PATRÓN SILVER 18/33
PATRÓN REPOSADO 19/35
DON JULIO BLANCO 18/33
DON JULIO REPOSADO 19/35
CASAMIGOS BLANCO 17/31
CASAMIGOS REPOSADO 20/35
CASAMIGOS AÑEJO 21/39
CASAMIGOS MEZCAL 22/44
TROMBA 13/23
HORNETS BLACK BARREL 13/23
LEYENDA TLACUACHE
ORGANIC MEZCAL 22/41
ALTOS 13/23
ESPOLÓN BLANCO 15/26

PREMIUM TEQUILA 1oz / 2oz

PATRÓN PLATINUM 56/109
DON JULIO 1942 60/117
CLASE AZUL REPOSADO 55/107

SHERRY / GRAPPA / PORT 1oz / 2oz

HARVEY'S BRISTOL CREAM 10
BOTTEGA SARPA DI POLI 11
TAYLOR FLADGATE 10 YEAR 15

GIN 1oz / 2oz

BOMBAY SAPPHIRE 12/21
TANQUERAY NO. TEN 12/21
AVIATION 12/21
HENDRICK'S 14/25
THE BOTANIST 14/25
GRAY WHALE 15/26
VALLEY OF MOTHER OF GOD 16/27
EMPRESS 1908 16/27

RUM 1oz / 2oz

CAPTAIN MORGAN SPICED 12/20
HAVANA CLUB 7 YEAR 14/25
EL DORADO 12 YEAR 14/25
EL DORADO 15 YEAR 17/31
BUMBU X 20/37
APPLETON ESTATE 15 YEAR
BLACK RIVER CASK 21/29

COGNAC / ARMAGNAC 1oz / 2oz

ARMAGNAC DE
MONTAL VSOP 16/29
HENNESSY VSOP 21/39
RÉMY MARTIN VSOP 21/39
COURVOISIER VSOP 21/39
HENNESSY XO 42/81
RÉMY MARTIN XO 42/81
COURVOISIER XO 42/81
MARTELL XO 89/175

PREMIUM COGNAC 0.5 oz / 1oz

HENNESSY PARADIS 205 / 345
RÉMY MARTIN LOUIS XIII 250 / 400

LIQUEURS 1oz / 2oz

COINTREAU 11/19
BAILEYS 11/19
KAHLÚA 11/19
TIA MARIA 11/19
SOUTHERN COMFORT 13/23
EL GOBERNADOR PISCO 14/25
GRAND MARINER
LOUIS ALEXANDRE 21/39
DISARONNO AMARETTO 12/21
AMARO NONINO 18/33
AVERNA AMARO 14/25
FERNET-BRANCA 12/21

SINGLE MALT SCOTCH 1oz / 2oz

OBAN 14 YEAR 34/65
THE GLENLIVET 12 YEAR 21/39
THE MACALLAN SHERRY OAK 55/107
GLENFIDDICH 18 YEAR 34/65
GLENKINCHIE 12 YEAR 22/41
LAPHROAIG 10 YEAR 22/41
TALISKER 10 YEAR 24/45
JURA SEVEN WOOD 55/107
DALWHINNIE 15 YEAR 23/43
LAGAVULIN 16 YEAR 34/65
THE DALMORE CIGAR MALT 55/107

BLENDED SCOTCH WHISKY 1oz / 2oz

CHIVAS REGAL 12 YEAR 17/31
CHIVAS REGAL 18 YEAR 24/45
JOHNNIE WALKER
BLACK LABEL 14/25
JOHNNIE WALKER
BLUE LABEL 60/117
SUNTORY WORLD WHISKY AO 25/47
MONKEY SHOULDER 15/27

BOURBON 1oz / 2oz

WOODFORD RESERVE 19/35
MAKER'S MARK 46 21/39
BUFFALO TRACE 16/29
BASIL HAYDEN 17/39
BULLEIT 16/29
ELIJAH CRAIG 17/31
WILD TURKEY RARE BREED 18/23
LEGENT YAMAZAKI 55/107

AMERICAN WHISKEY 1oz / 2oz

GENTLEMAN JACK
TENNESSEE WHISKEY 13/23
HEAVEN'S DOOR DOUBLE BARREL 22/41

CANADIAN WHISKY 1oz / 2oz

CROWN ROYAL 12/21
FORTY CREEK
CONFEDERATION OAK 19/31
GOODERHAM & WORTS 15/26
BEARFACE 16/31
SIGNAL HILL 14/25
CANADIAN CLUB
CLASSIC 18 YEAR 22/41

IRISH WHISKEY 1oz / 2oz

JAMESON 13/23
GLENDALOUGH 15/27
REDBREAST 12 YEAR IRISH 24/45

Spirits

SHAREABLE & SMALL BITES

CHARCUTERIE 39

niagara cured meats,
country pâté, artisanal
cheese, raw and pickled
vegetables, crisp
farmhouse breads

**ARTISANAL
CHEESE BOARD** 21

local and imported
cheese, pickled
vegetables and mustard
seeds, grape preserves,
crisp farmhouse breads

CHIPS & DIPS 15

sour cream and
caramelized onion dip,
salsa, kettle chips

**MEDITERRANEAN
PLATTER** 36

hummus, baba ganoush,
sour cream and
caramelized onion
dip, marinated olives,
dolmades, pickled
vegetables, pita and
flatbreads

MARINATED OLIVES 17

spiced & citrus-marinated
olives and rosemary
focaccia croutons

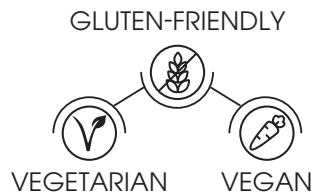

Gluten-friendly bread available upon request.

*Consuming raw or undercooked meats, poultry, seafood, shellfish or
eggs may increase your risk of foodborne illness.

Please notify us of any food allergy.

HOT COFFEE & TEA

STANCE COFFEE 8
SLOANE HOT TEA 7
ESPRESSO 6/8
MACCHIATO 6
CAPPUCCINO 8
AMERICANO 7
CAFE LATTE 7
HOT CHOCOLATE 6

OTHER BEVERAGES

FRESH-SQUEEZED
ORANGE JUICE 7

FIZZ

RED BULL ENERGY DRINK 7
RED BULL SUGARFREE 7
S.PELLEGRINO SPARKLING
MINERAL WATER 500ML 7
S.PELLEGRINO SPARKLING
MINERAL WATER 1 LTR 10
COKE / DIET COKE
CANADA DRY 6
FEVER-TREE SODA 7

FLAT

ACQUA PANNA 500ML 7
ACQUA PANNA 1 LTR 10

With sincere gratitude we give thanks
to our partners who build community
and promote sustainability.

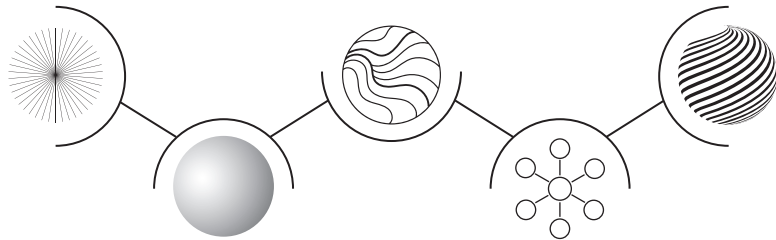

COMMUNITY

Appleton Estate Rum: In 1997, Dr. Joy Spence became the first woman appointed master blender in the industry, an amazing milestone for women across the world!

Woodford Reserve Bourbon: Woodford Reserve works closely with Old Friend Farms, where racing thoroughbreds are sent to retire and raise awareness of the importance of equine aftercare.

SUSTAINABILITY

Patrón Tequila: Patrón was the first distillery to install a natural gas pipeline, which acts as its main energy source and helps reduce CO2 emissions in the atmosphere.

Absolut Vodka: For the past four years, Absolut has been using so-called waste spirits to reduce use of liquefied propane gas (LPG) to generate energy at their Nöbbelöv distillery.

Seedlip: Seedlip is a 1% for the Planet member, giving 1% of global annual revenues to environmental charities dedicated to celebrating and protecting the planet.

