

## ELEMENTS OF DRINK DESIGN

Much like a well-designed object, a well-crafted cocktail takes into account the contributions of each element and how they play against each other. Balance and tension, comfort and elevation, the nuances of technique and ingredient make each cocktail unique.

### *The Elements of a Cocktail*

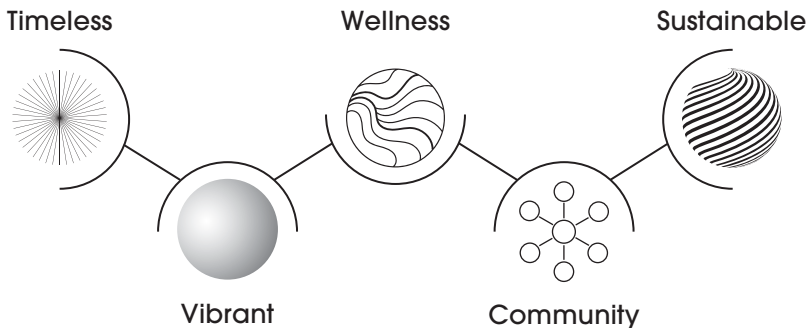



**BUILD YOUR OWN HIGHBALL 18**

*Choose your Spirit:*

**VODKA**

Tito's Handmade  
Belvedere Organic  
Grey Goose

**TEQUILA**

Herradura Silver  
Casamigos Reposado  
Milagro Añejo

**BOURBON**

Bulleit  
Maker's Mark  
Woodford Reserve

*Choose your Mixer:*

Q Club Soda  
Owen's Rio Red Grapefruit  
Owen's American Tonic  
Q Ginger Ale  
Owen's Ginger Beer

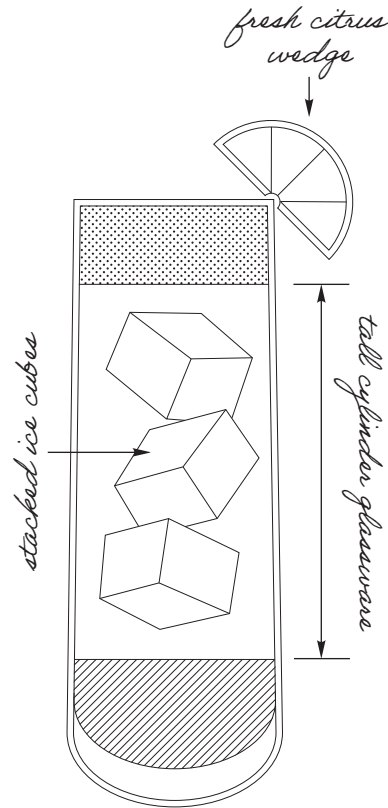

*composed of an alcoholic base spirit and a larger proportion of a non-alcoholic mixer.*



**AMERICANO HIGHBALL 16**

Campari, Antica Formula Sweet Vermouth, Q Club Soda

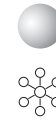

**OF ALL THINGS 18**

21 Seeds Grapefruit Hibiscus  
Tequila, Aperol, Barmalade  
Grapefruit-Elderflower,  
fresh lime, rhubarb bitters,  
Lunetta Prosecco

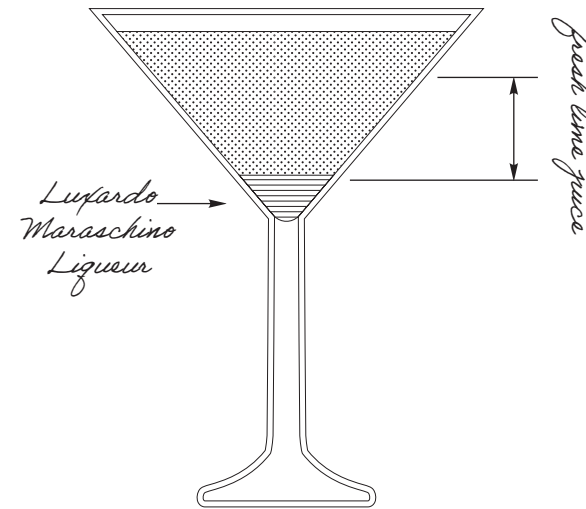

*edible micro flowers*

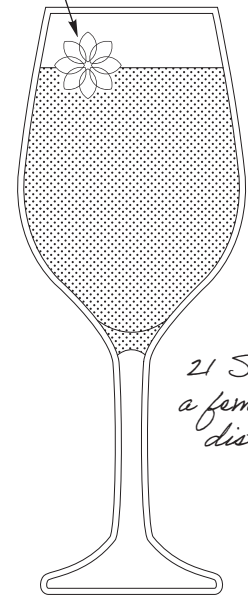

**THE LAST WORD MARTINI 20**

Hendrick's Gin, green chartreuse,  
Luxardo Maraschino Liqueur,  
fresh lime

*Make it smoky with Dos Hombres Mezcal 22*

ELEMENT KEY	
	Timeless
	Vibrant
	Wellness
	Community
	Sustainable

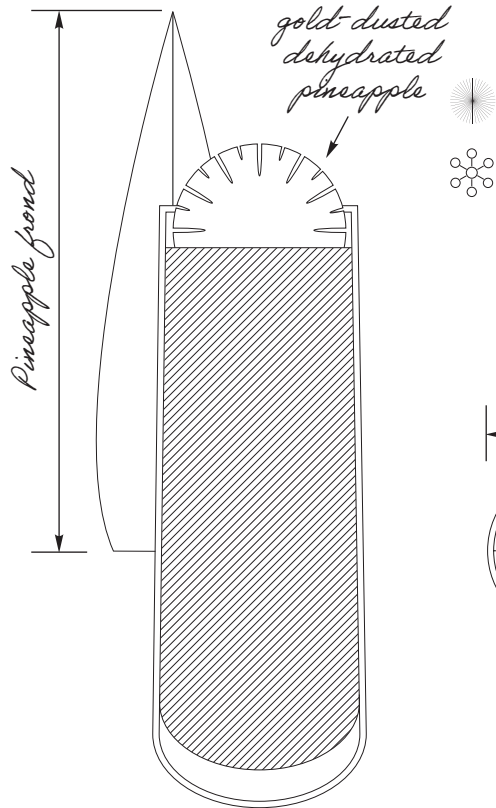

**JUNGLE BIRD 17**  
 Appleton Estate Signature Blend Rum, Campari, Liber & Co. Pineapple Gum Syrup, fresh lime, pineapple juice

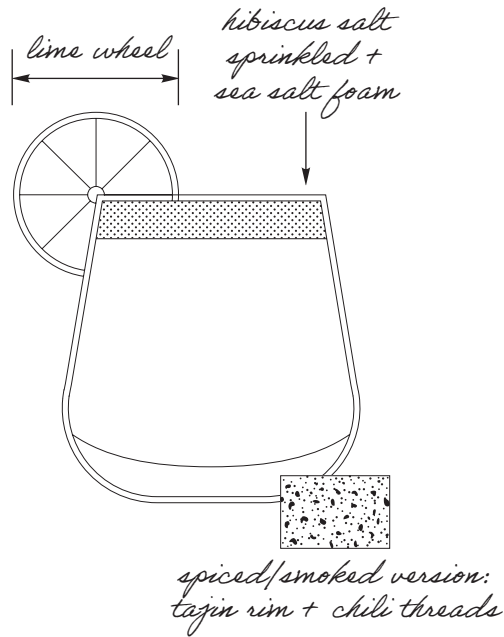

**MARGARITA 19**  
 Patrón Silver Tequila, Italicus Rosolio di Bergamotto, fresh lime, Monin Agave Nectar

- Level up with Herradura Reposado 20*
- Make it spicy with Ancho Reyes Chile Liqueur 21*
- Try it smoky with Dos Hombres Mezcal 21*

ELEMENT KEY	
	Timeless
	Vibrant
	Wellness
	Community
	Sustainable

**CLASSIC MARTINI**  
 DRY / STIRRED 20  
 The Botanist Gin or Ketel One Vodka, Carpano Dry Vermouth, orange bitters, lemon twist

**DIRTY / SHAKEN 19**  
 Tito's Handmade Vodka, Carpano Bianco Vermouth, house brine, Filthy Foods Olive Accoutrements

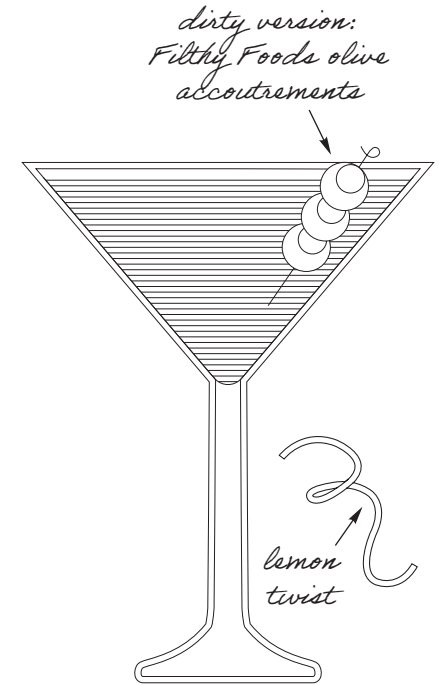

**ESPRESSO MARTINI 19**  
 Absolut Vodka, Kahlúa, fresh espresso

*Twist it up with Casamigos Reposado Tequila 21*

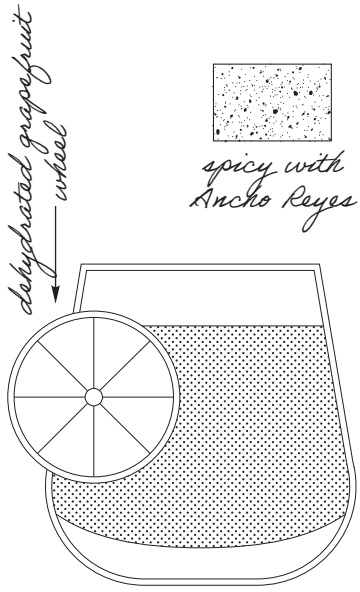

originally called the "De Rigueur" in cocktail books

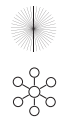

**BROWN DERBY 20**

Woodford Reserve Bourbon, fresh grapefruit, barrel-aged maple syrup, orange bitters

*Spice it up with Ancho Reyes Chile Liqueur 22*

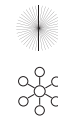
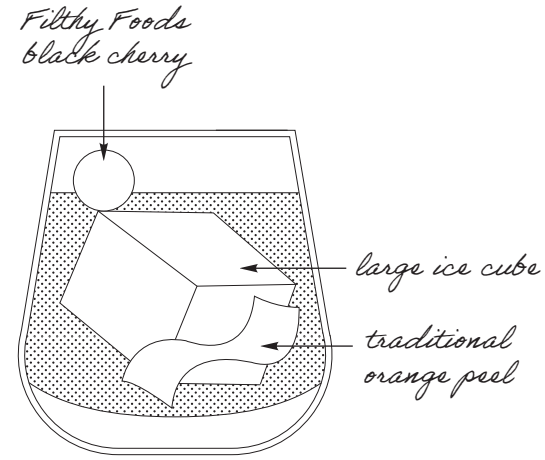

**OLD FASHIONED 19**

High West Bourbon, Liber & Co Demerara Syrup, El Guapo Bitters

*Level up with Garrison Brothers Small Batch Bourbon 21*

*Make it a twist featuring Cincoro Reposado Tequila 32*



**MANHATTAN 21**

Knob Creek 7 Yr. Rye Whiskey, Antica Formula Sweet Vermouth, Angostura Bitters

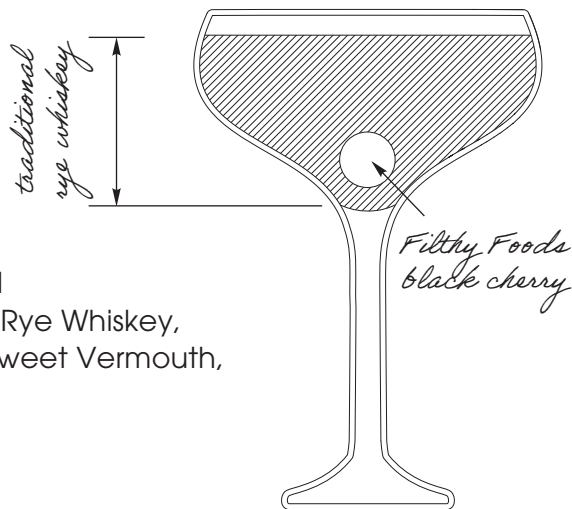

ELEMENT KEY	
	Timeless
	Vibrant
	Wellness
	Community
	Sustainable

*candied ginger slice*

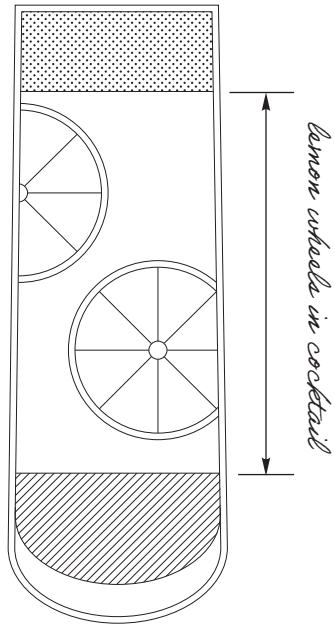

**SEAMLESS** 12

Monin Vanilla, Passion Fruit Reàl, fresh lemon, Q Club Soda



ELEMENT KEY	
	Timeless
	Vibrant
	Wellness
	Community
	Sustainable

*dehydrated blood orange wheel*

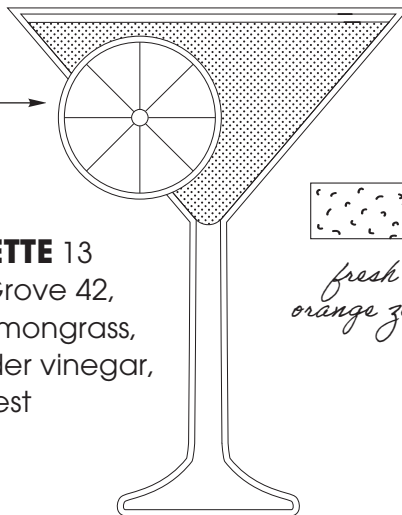

*fresh orange zest*



**SILHOUETTE** 13

Seedlip Grove 42, Monin Lemongrass, apple cider vinegar, orange zest



**DOMESTIC** 7

- MICHELOB ULTRA
- COORS LIGHT
- MILLER LITE
- BUD LIGHT
- BUDWEISER

**IMPORTED** 8

- CORONA EXTRA
- DOS EQUIS LAGER
- HEINEKEN
- PERONI
- STELLA ARTOIS
- GUINNESS
- MODELO ESPECIAL

**NON-ALCOHOLIC** 7

- HEINEKEN 0.0 NA LAGER
- ATHLETIC BREWING CO
- RUN WILD NA IPA

**CRAFT** 8

- SAMUEL ADAMS BOSTON LAGER
- SAMUEL ADAMS SEASONAL
- NEW BELGIUM FAT TIRE ALE
- NEW BELGIUM VOODOO
- RANGER JUICY HAZE IPA
- BLUE MOON BELGIAN WHITE
- KARBACH HOPADILLO IPA
- INDEPENDENCE STASH IPA
- YUENGLING AMERICAN LAGER



**HARD SELTZERS**

**& CIDERS** 7

- ANGRY ORCHARD HARD CIDER
- AUSTIN EASTCIDERS CIDER
- WHITE CLAW MANGO HARD SELTZER
- WHITE CLAW BLACK CHERRY HARD SELTZER
- TRULY WILD BERRY HARD SELTZER
- HIGH NOON WATERMELON VODKA HARD SELTZER

White Wines

White Wines

<i>Intensity</i>									
Fruit	Tannin	Acidity							
							6oz	9oz	BTL
●	○	●	LUNETTA • <b>Prosecco Brut</b>	Veneto, Italy (187ml)					14
●	○	○	CHANDON • <b>Sparkling Rosé</b>	California (187ml)					19
○	○	●	MOËT & CHANDON IMPÉRIAL • <b>Brut Rosé</b>	Champagne, France (187ml)					36
●	○	○	CHATEAU STE. MICHELLE • <b>Riesling</b>	Columbia Valley, Washington			12	18	48
●	○	○	CONUNDRUM • <b>White Blend</b>	California			15	20	56
○	○	●	SANTA MARGHERITA • <b>Pinot Grigio</b>	Valdadige, Veneto, Italy			23	32	88
○	○	●	ROSE GOLD • <b>Rosé</b>	Côtes de Provence, France			17	23	64
○	○	○	MERRYVALE • <b>Sauvignon Blanc</b>	Napa Valley, California			25	35	96
●	○	●	MOHUA • <b>Sauvignon Blanc</b>	Marlborough, New Zealand			16	22	60
●	○	○	WENTE VINEYARDS ESTATE GROWN • <b>Chardonnay</b>	Central Coast, California			16	22	60
○	○	○	ORIN SWIFT MANNEQUIN • <b>Chardonnay</b>	California			29	41	112

○ MIN ○ MID ● MAX

*Red Wines*

*Red Wines*



				6oz	9oz	BTL
● ○ ●	ELOUAN • <b>Pinot Noir</b>	Oregon		17	23	64
● ● ○	BELLE GLOS BALADE • <b>Pinot Noir</b>	Santa Barbara County, California		26	37	100
○ ● ●	BANFI • <b>Chianti Classico</b>	Tuscany, Italy		16	22	60
● ● ●	DUCKHORN • <b>Merlot</b>	Napa Valley, California		29	41	112
○ ● ●	CATENA VISTA FLORES • <b>Malbec</b>	Mendoza, Argentina		16	22	60
● ● ●	LIBERTY SCHOOL • <b>Cabernet Sauvignon</b>	Paso Robles, California		16	22	60
● ○ ○	J. LOHR PURE PASO • <b>Red Blend</b>	Paso Robles, California		23	32	88
● ● ●	THE PRISONER WINE COMPANY UNSHACKLED <b>Cabernet Sauvignon</b>	California		21	29	80
● ● ●	DAOU • <b>Cabernet Sauvignon</b>	Paso Robles, California		19	26	72

○ MIN ● MID ● MAX

BOARDS

**CHEESE AND CHARCUTERIE** 26

selection of cured meats, artisanal cheeses, seasonal accoutrements



**FRESH CRUDITÉS** 17

roasted garlic hummus, baba ganoush, crackers

DIPS



**ARTICHOKE & SPINACH** 18

crispy parmesan panko crust, lavash



**BEER CHEESE** 19

warm pretzels



**PIMENTO CHEESE** 12

chips



GLUTEN-FRIENDLY

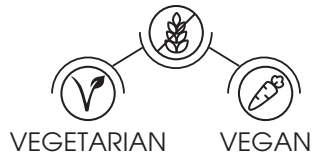

SNACKS



**WARMED OLIVES** 14

orange, fennel, goat cheese



**CRACKLINS** 9

bbq spice-rubbed



**SPICED NUTS** 10

roasted & salted



SWEETS



**TEXAS TIRAMISU** 10

texas bourbon, caramelized peaches



**S'MORES POT DE CRÈME** 12

chocolate pot de crème, burnt marshmallow panna cotta, salted pecan streusel



Gluten-friendly bread available upon request.

\*Consuming raw or undercooked meats, poultry, seafood, shellfish or eggs may increase your risk of foodborne illness.

Please notify us of any food allergy.



**HOT COFFEE & TEA**

STANCE COFFEE 4

NUMI HOT TEA 4

**FIZZ**

RED BULL ENERGY DRINK 7

RED BULL SUGARFREE 7

S.PELLEGRINO SPARKLING  
MINERAL WATER 500ML 5

S.PELLEGRINO ESSENZA  
ASSORTED 5

**FLAT**

ACQUA PANNA 500ML 5

With sincere gratitude we give thanks  
to our partners who build community  
and promote sustainability.

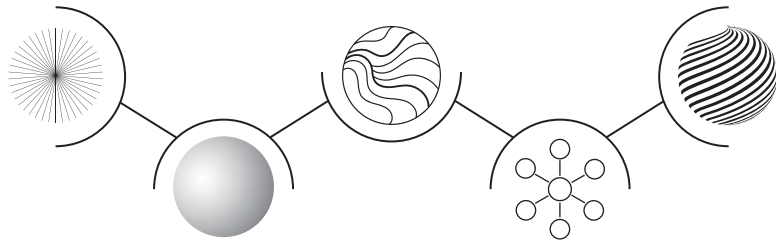

## COMMUNITY

**Owen's American Tonic:** Helping to raise awareness to Fields of Honor in support of families of fallen or disabled military and first responders with more than 35,000 scholarships awarded since 2007.

**21 Seeds Tequila:** Female-founded infused tequila inspiring you to gather your tribe of friends new and old, cross borders, share ideas, and make connections.

**Appleton Estate Rum:** In 1997, Dr. Joy Spence became the first woman appointed master blender in the industry, an amazing milestone for women across the world!

**Woodford Reserve Bourbon:** Woodford Reserve works closely with Old Friend Farms, where racing thoroughbreds are sent to retire and raise awareness of the importance of equine aftercare.

**High West Bourbon:** Pledged \$1,000,000 over the next three years to organizations that are working to protect the West from wildfires – including Wildland Firefighter Foundation, Protect Our Winters (POW), and American Prairie Reserve.

**Monin:** Honored to partner with organizations making a positive impact including Grounds for Health, Children of Restaurant Employees (CORE), and Step Up for Students.

## SUSTAINABILITY

**Patrón Tequila:** Patrón was the first distillery to install a natural gas pipeline, which acts as its main energy source and helps reduce CO2 emissions in the atmosphere.

**Absolut Vodka:** For the past four years, Absolut has been using so-called waste spirits to reduce use of liquefied propane gas (LPG) to generate energy at their Nöbbelöv distillery.

**Seedlip:** Seedlip is a 1% for the Planet member, giving 1% of global annual revenues to environmental charities dedicated to celebrating and protecting the planet.