

ELEMENTS OF DRINK DESIGN

Much like a well-designed object, a well-crafted cocktail takes into account the contributions of each element and how they play against each other. Balance and tension, comfort and elevation, the nuances of technique and ingredient make each cocktail unique.

The Elements of a Cocktail

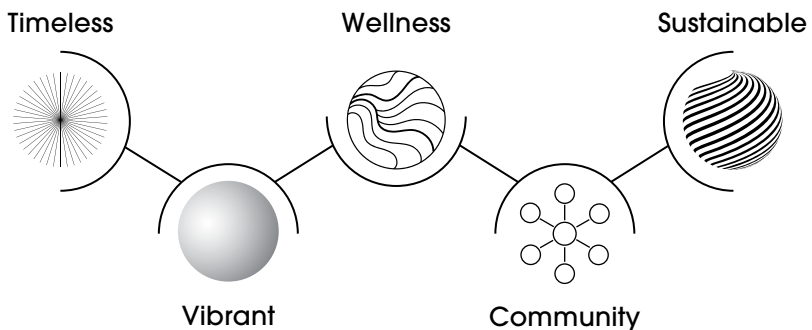

Cocktails



BUILD YOUR OWN HIGHBALL 15

Choose your Spirit:

VODKA

Tito's Handmade
Belvedere Organic
Grey Goose

TEQUILA

Herradura Silver
Casamigos Reposado
Milagro Añejo

BOURBON

Bulleit
Maker's Mark
Woodford Reserve

Choose your Mixer:

Q Club Soda
Owen's Rio Red Grapefruit
Owen's American Tonic
Q Ginger Ale
Owen's Ginger Beer

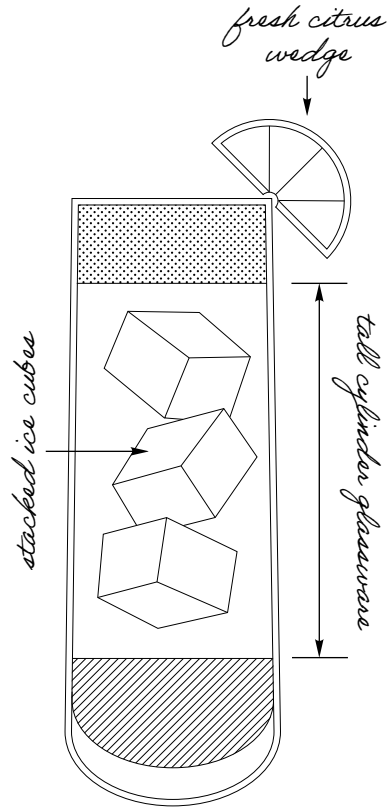

composed of an alcoholic base spirit and a larger proportion of a non-alcoholic mixer.



AMERICANO HIGHBALL 15

Campari, Antica Formula Sweet
Vermouth, Q Club Soda

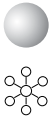

OF ALL THINGS 13

21 Seeds Grapefruit Hibiscus
Tequila, Aperol, Barmalade
Grapefruit-Elderflower,
fresh lime, rhubarb bitters,
Lunetta Prosecco

*edible micro
flowers*

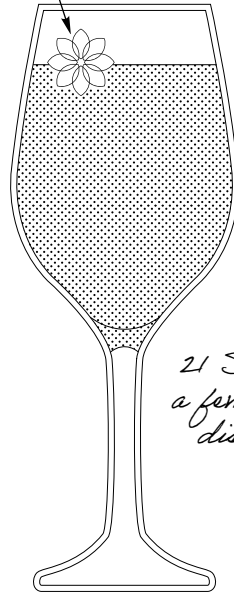

*21 Seeds is
a female-led
distillery*

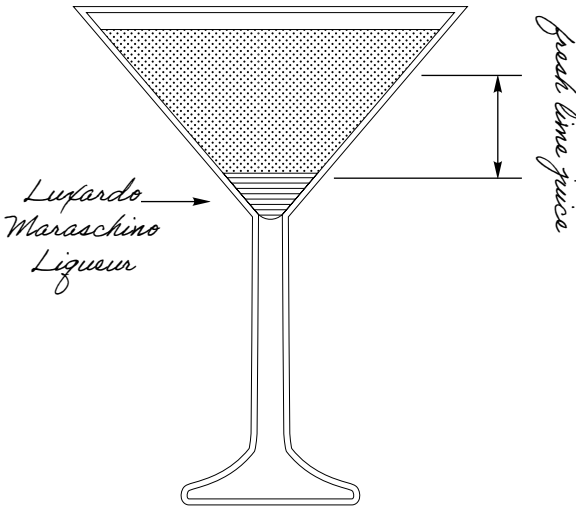

*Luxardo
Maraschino
Liqueur*

fresh lime juice



THE LAST WORD MARTINI 16

Hendrick's Gin, green chartreuse,
Luxardo Maraschino Liqueur,
fresh lime

Make it smoky with Dos Hombres Mezcal 17

ELEMENT KEY



Timeless



Vibrant



Wellness



Community



Sustainable

Cocktails

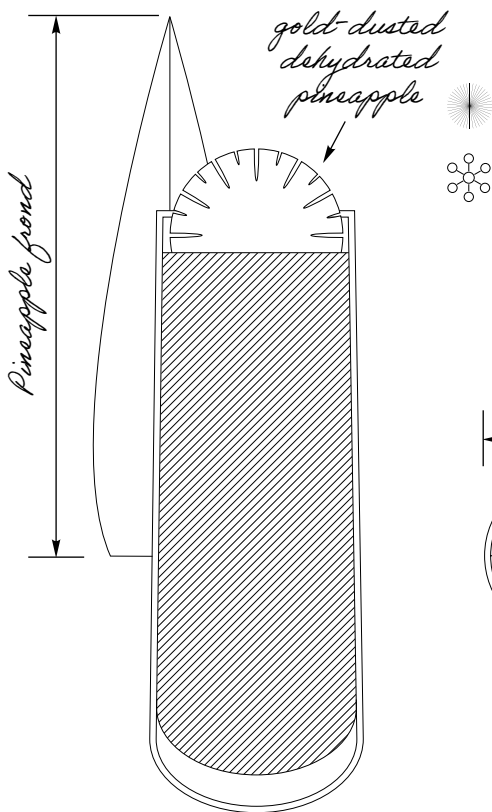



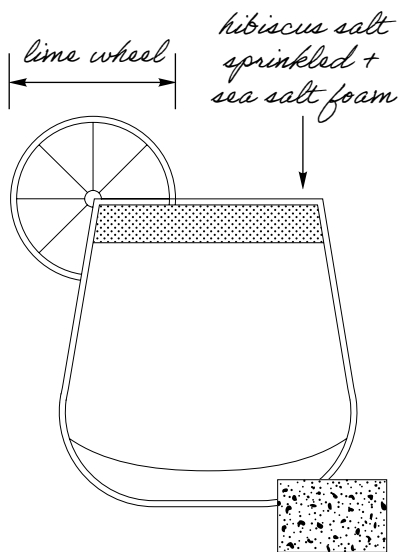

JUNGLE BIRD 13

Appleton Estate Signature Blend Rum, Campari, Liber & Co. Pineapple Gum Syrup, fresh lime, pineapple juice



spiced/smoked version: tajin rim + chili threads

ELEMENT KEY	
	Timeless
	Vibrant
	Wellness
	Community
	Sustainable



MARGARITA 16

Patrón Silver Tequila, Italicus Rosolio di Bergamotto, fresh lime, Monin Agave Nectar

Level up with Herradura Reposado 17

Make it spicy with Ancho Reyes

Chile Liqueur 18

Try it smoky with Dos Hombres Mezcal 18



CLASSIC MARTINI

DRY / STIRRED 16

The Botanist Gin or
Ketel One Vodka, Carpano
Dry Vermouth, orange bitters,
lemon twist

DIRTY / SHAKEN 15

Tito's Handmade Vodka,
Carpano Bianco Vermouth,
house brine, Filthy Foods Olive
Accoutrements

*dirty version:
Filthy Foods olive
accoutrements*

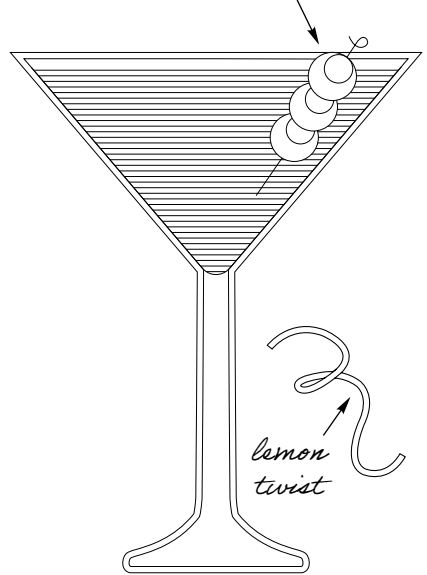

3 espresso beans

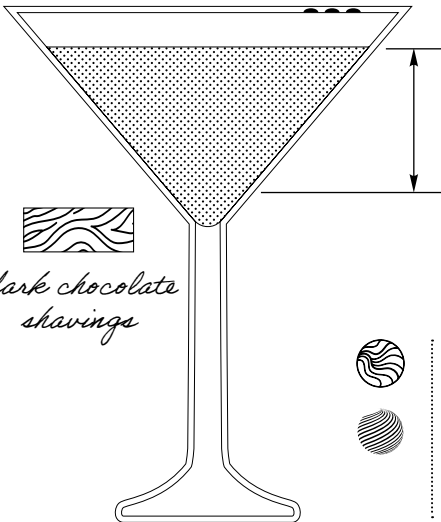

*fresh-brewed
espresso*

*dark chocolate
shavings*



ESPRESSO MARTINI 15

Absolut Vodka, Kahlúa,
fresh espresso

*Twist it up with Casamigos
Reposado Tequila 18*

Cocktails

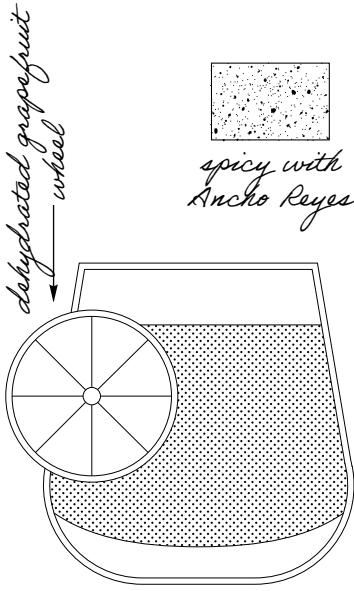

originally called the "De Rigueur" in cocktail books

BROWN DERBY 16

Woodford Reserve Bourbon, fresh grapefruit, barrel-aged maple syrup, orange bitters

Spice it up with Ancho Reyes Chile Liqueur 17

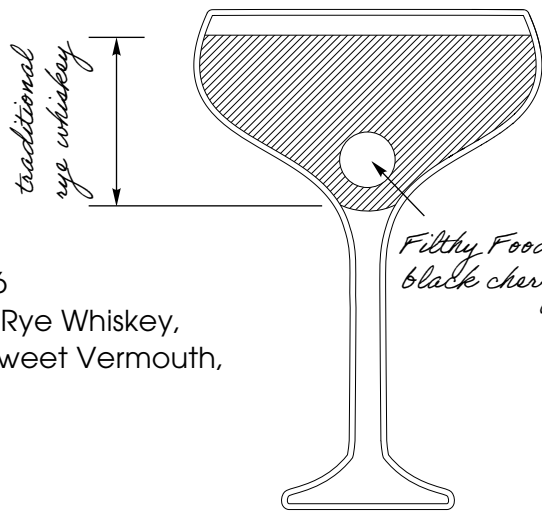
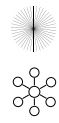

MANHATTAN 16

Knob Creek 7 Yr. Rye Whiskey, Antica Formula Sweet Vermouth, Angostura Bitters



*Filthy Foods
black cherry*

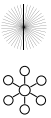
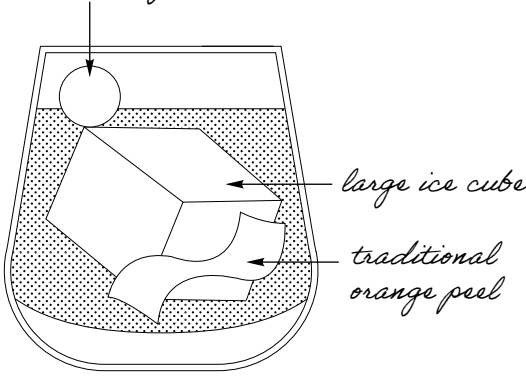





OLD FASHIONED 16

High West Bourbon, Liber & Co Demerara Syrup,
El Guapo Bitters

Level up with Garrison Brothers Small Batch Bourbon 25

Make it a twist featuring Cincoro Reposado Tequila 27

ELEMENT KEY	
	Timeless
	Vibrant
	Wellness
	Community
	Sustainable

Mocktails

candied ginger slice

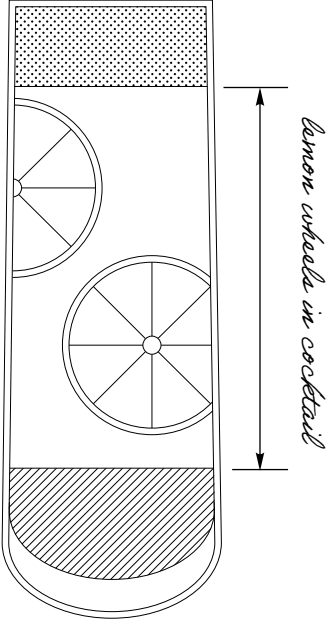

SEAMLESS 10

Monin Vanilla, Passion Fruit Reàl, fresh lemon, Q Club Soda

ELEMENT KEY	
	Timeless
	Vibrant
	Wellness
	Community
	Sustainable

dehydrated blood orange wheel

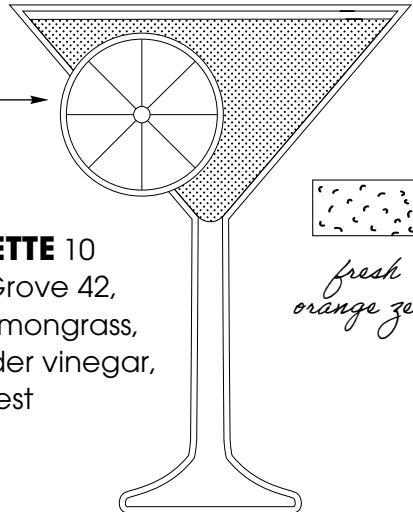

SILHOUETTE 10

Seedlip Grove 42, Monin Lemongrass, apple cider vinegar, orange zest

fresh orange zest

DOMESTIC 7

MICHELOB ULTRA
COORS LIGHT
MILLER LITE
BUD LIGHT
BUDWEISER

IMPORTED 8

CORONA PREMIUM
DOS EQUIS LAGER
HEINEKEN
PERONI
STELLA ARTOIS
GUINNESS
MODELO ESPECIAL

NON-ALCOHOLIC 7

HEINEKEN 0.0 NA LAGER
ATHLETIC BREWING CO
RUN WILD NA IPA

CRAFT 8

SAMUEL ADAMS
BOSTON LAGER
SAMUEL ADAMS SEASONAL
NEW BELGIUM FAT TIRE ALE
NEW BELGIUM VODOO
RANGER JUICY HAZE IPA
BLUE MOON BELGIAN WHITE
COOP F5
ROUGHTAIL EVERYTHING
RHYMES WITH ORANGE
STONECLOUD NEON SUNSHINE
YUENGLING
AMERICAN LAGER

HARD SELTZERS & CIDERS

ANGRY ORCHARD
HARD CIDER 7
PRAIRIE RAINBOW SHERBET
HARD CIDER 8
WHITE CLAW MANGO
HARD SELTZER 7
WHITE CLAW BLACK CHERRY
HARD SELTZER 7
TRULY WILD BERRY
HARD SELTZER 7
HIGH NOON WATERMELON
VODKA HARD SELTZER 8

White Wines

Intensity

Fruit



Tannin



Acidity



LUNETTA • **Prosecco Brut**



CHANDON • **Sparkling Rosé**



CHATEAU STE. MICHELLE • **Riesling**



ZENATO • **Pinot Grigio**



SANTA MARGHERITA • **Pinot Grigio**



CHÂTEAU D'ESCLANS WHISPERING ANGEL • **Rosé**



DECOY BY DUCKHORN • **Sauvignon Blanc**



MOHUA • **Sauvignon Blanc**



PINE RIDGE • **Chenin Blanc/Viognier**



WENTE VINEYARDS ESTATE GROWN • **Chardonnay**



KENDALL-JACKSON VINTNER'S RESERVE • **Chardonnay**

○ MIN ◐ MID ● MAX

White Wines

	6oz	9oz	BTL
Veneto, Italy (<i>187ml</i>)	-	-	13
California (<i>187ml</i>)	-	-	15
Columbia Valley, Washington	16	23	62
delle Venezie, Italy	11	15	42
Valdadidge, Veneto, Italy	17	24	67
Côtes de Provence, France	15	20	56
California	14	20	54
Marlborough, New Zealand	12	17	46
California	11	15	42
Central Coast, California	11	15	42
California	12	17	46

Red Wines

Intensity

Fruit



Tannin



Acidity



MEOMI • **Pinot Noir**



BELLE GLOS BALADE • **Pinot Noir**



BENZIGER • **Merlot**



DUCKHORN • **Merlot**



CATENA VISTA FLORES • **Malbec**



LIBERTY SCHOOL • **Cabernet Sauvignon**



JOEL GOTT • **Red Blend**



J. LOHR PURE PASO • **Red Blend**



THE PRISONER WINE COMPANY UNSHACKLED
Cabernet Sauvignon



DAOU • **Cabernet Sauvignon**

○ MIN ● MID ● MAX

Red Wines

	6oz	9oz	BTL
California	17	24	66
Santa Barbara County, California	20	27	75
Sonoma County, California	11	16	44
Napa Valley, California	14	20	54
Mendoza, Argentina	11	15	42
Paso Robles, California	14	20	54
Columbia Valley, Washington	12	17	46
Paso Robles, California	18	26	70
California	17	24	66
Paso Robles, California	18	26	70

BOARDS

MEAT & CHEESE BOARD 22

chef's selection of charcuterie, imported & domestic cheese, house pickled vegetables, grain mustard, housemade bread



HONEY WHIPPED GOAT CHEESE & OLIVE TAPENADE 12

walnut & scallion baguette

DIPS



SWEET POTATO



HUMMUS 12

candied pecan crumble, lavash



CARAMELIZED SHALLOT DIP 12

aged cheddar, housemade kettle chips

SHRIMP ELOTE DIP 14

citrus seared shrimp, roasted corn, cotija cheese, cilantro, jalapeños, tajín, flatbread chips

SNACKS

DUCK FAT FRIES 12

french fries, duck fat,
parmesan, herbs,
sea salt



**OKLAHOMA
POPCORN
DUO** 12

white cheddar,
dill pickle

SWEETS

DESSERT SHOTS 12

banana pudding,
caramel cream pecan
pie, chocolate overload
& berry shortcake



OKC AFFOGATO 12

vanilla bean gelato,
espresso, salted pecan
brittle

LARGE PLATES

BISON SLIDERS 20

crispy pork belly, whiskey onions, gruyère, arugula, garlic aioli, onion brioche

BEEF SHORT RIB SLIDERS 20

wild mushrooms, cabernet demi-glace, crispy onions, onion brioche



SHRIMP LETTUCE WRAPS 18

grilled shrimp, spicy black garlic sambal sauce, charred shishitos, scallion, boston lettuce, crispy garlic, housemade pickles, garlic aioli

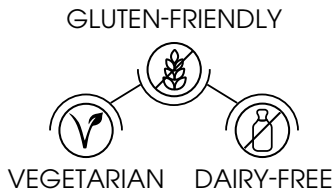

Gluten-friendly bread available upon request.

*Consuming raw or undercooked meats, poultry, seafood, shellfish or eggs may increase your risk of foodborne illness.

Please notify us of any food allergy.

HOT COFFEE & TEA

STANCE COFFEE 4

NUMI HOT TEA 4

ESPRESSO 5

OTHER BEVERAGES

FRESH-SQUEEZED ORANGE JUICE 6

“THE STATE DRINK” LEMONADE 4

ARIZONA BEVERAGES 4

FIZZ

RED BULL ENERGY DRINK 7

RED BULL SUGARFREE 7

S.PELLEGRINO SPARKLING

MINERAL WATER 500ML 5

S.PELLEGRINO ESSENZA ASSORTED 5

FLAT

ACQUA PANNA 500ML 5

With sincere gratitude we give thanks
to our partners who build community
and promote sustainability.

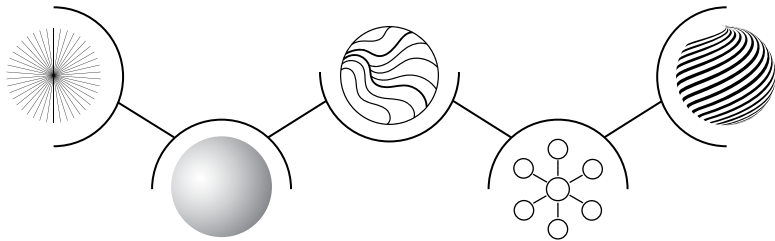



COMMUNITY

Owen's American Tonic: Helping to raise awareness to Fields of Honor in support of families of fallen or disabled military and first responders with more than 35,000 scholarships awarded since 2007.

21 Seeds Tequila: Female-founded infused tequila inspiring you to gather your tribe of friends new and old, cross borders, share ideas, and make connections.

Appleton Estate Rum: In 1997, Dr. Joy Spence became the first woman appointed master blender in the industry, an amazing milestone for women across the world!

Woodford Reserve Bourbon: Woodford Reserve works closely with Old Friend Farms, where racing thoroughbreds are sent to retire and raise awareness of the importance of equine aftercare.

High West Bourbon: Pledged \$1,000,000 over the next three years to organizations that are working to protect the West from wildfires – including Wildland Firefighter Foundation, Protect Our Winters (POW), and American Prairie Reserve.

Monin: Honored to partner with organizations making a positive impact including Grounds for Health, Children of Restaurant Employees (CORE), and Step Up for Students.



SUSTAINABILITY

Patrón Tequila: Patrón was the first distillery to install a natural gas pipeline, which acts as its main energy source and helps reduce CO2 emissions in the atmosphere.

Absolut Vodka: For the past four years, Absolut has been using so-called waste spirits to reduce use of liquefied propane gas (LPG) to generate energy at their Nöbbelöv distillery.

Seedlip: Seedlip is a 1% for the Planet member, giving 1% of global annual revenues to environmental charities dedicated to celebrating and protecting the planet.