

ELEMENTS OF DRINK DESIGN

Much like a well-designed object, a well-crafted cocktail takes into account the contributions of each element and how they play against each other. Balance and tension, comfort and elevation, the nuances of technique and ingredient make each cocktail unique.

The Elements of a Cocktail

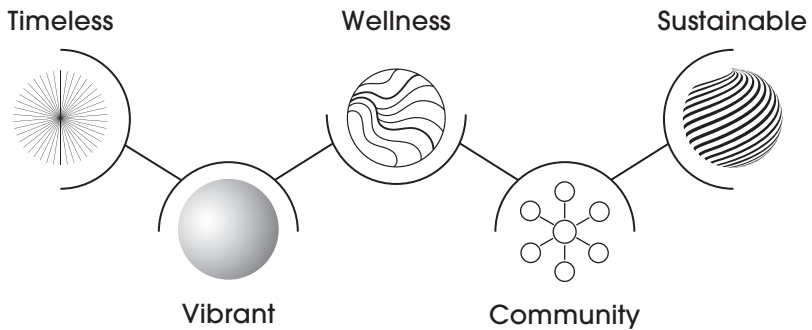



BUILD YOUR OWN HIGHBALL 16

Choose your Spirit:

VODKA

Tito's Handmade
Belvedere Organic
Grey Goose

TEQUILA

Herradura Silver
Casamigos Reposado
Milagro Añejo

BOURBON

Bulleit
Maker's Mark
Woodford Reserve

Choose your Mixer:

Q Club Soda
Owen's Rio Red Grapefruit
Owen's American Tonic
Q Ginger Ale
Owen's Ginger Beer

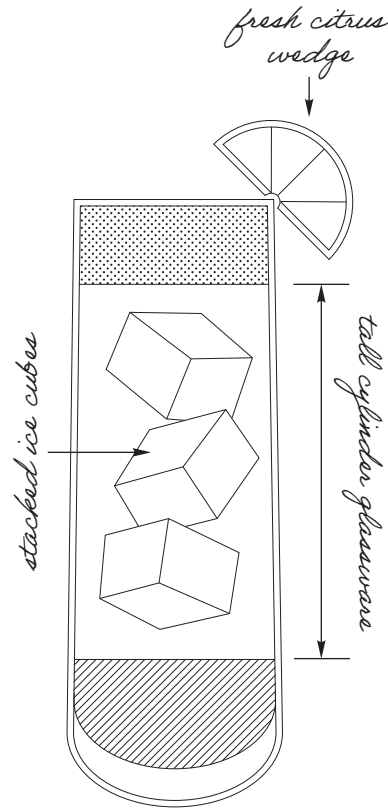

composed of an alcoholic base spirit and a larger proportion of a non-alcoholic mixer.



AMERICANO HIGHBALL 17

Campari, Antica Formula Sweet Vermouth, Q Club Soda

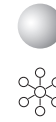

OF ALL THINGS 16

21 Seeds Grapefruit Hibiscus
Tequila, Aperol, Barmalade
Grapefruit-Elderflower,
fresh lime, rhubarb bitters,
Lunetta Prosecco

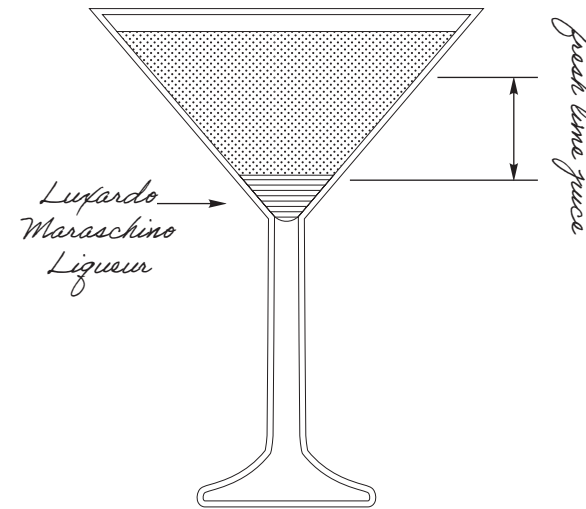

edible micro flowers

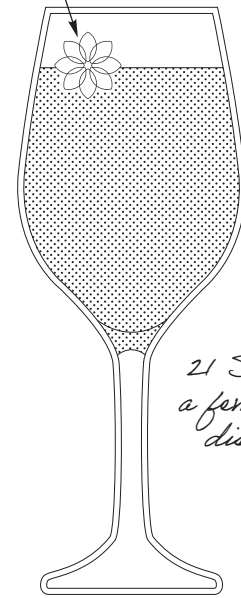

21 Seeds is a female-led distillery



THE LAST WORD MARTINI 20

Hendrick's Gin, green chartreuse,
Luxardo Maraschino Liqueur,
fresh lime

Make it smoky with Dos Hombres Mezcal 20

ELEMENT KEY	
	Timeless
	Vibrant
	Wellness
	Community
	Sustainable

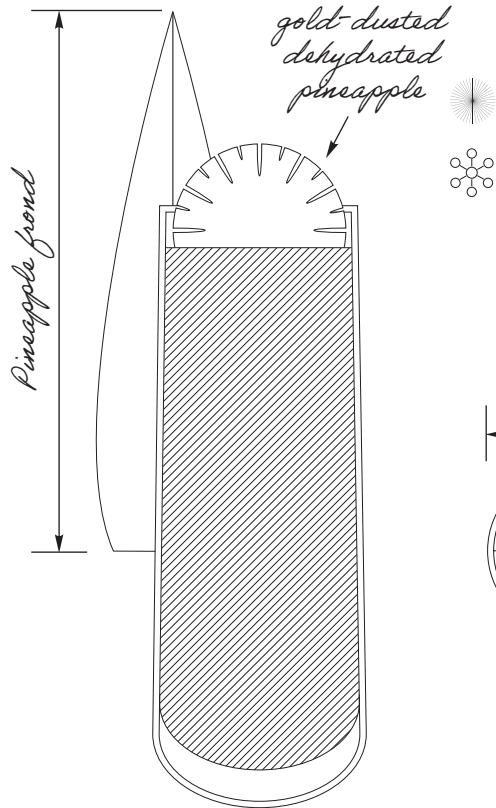

JUNGLE BIRD 16
 Appleton Estate Signature Blend Rum, Campari, Liber & Co. Pineapple Gum Syrup, fresh lime, pineapple juice

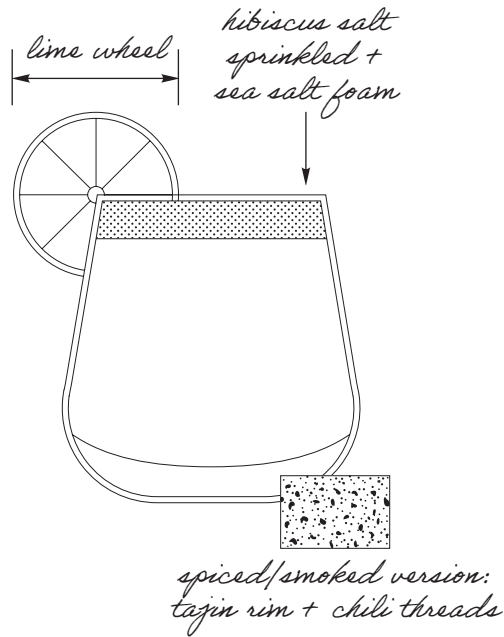

MARGARITA 16
 Patrón Silver Tequila, Italicus Rosolio di Bergamotto, fresh lime, Monin Agave Nectar

Level up with Herradura Reposado 17

Make it spicy with Ancho Reyes Chile Liqueur 18

Try it smoky with Dos Hombres Mezcal 18

ELEMENT KEY	
	Timeless
	Vibrant
	Wellness
	Community
	Sustainable

CLASSIC MARTINI 18
 DRY / STIRRED 18
 The Botanist Gin or Ketel One Vodka, Carpano Dry Vermouth, orange bitters, lemon twist

DIRTY / SHAKEN 18
 Tito's Handmade Vodka, Carpano Bianco Vermouth, house brine, Filthy Foods Olive Accoutrements

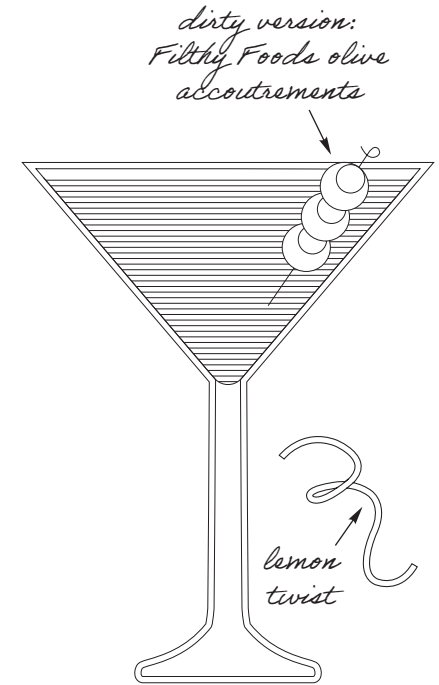

ESPRESSO MARTINI 18
 Absolut Vodka, Kahlúa, fresh espresso

Twist it up with Casamigos Reposado Tequila 23

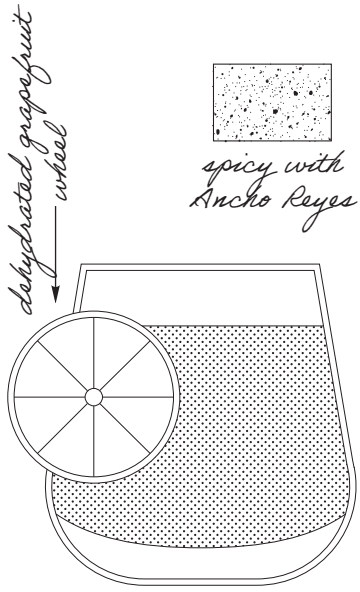

originally called the "De Rigueur" in cocktail books

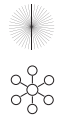

BROWN DERBY 18

Woodford Reserve Bourbon, fresh grapefruit, barrel-aged maple syrup, orange bitters

Spice it up with Ancho Reyes Chile Liqueur 20

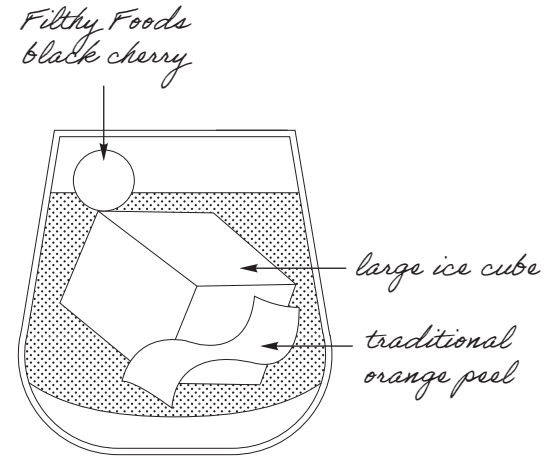

OLD FASHIONED 17

High West Bourbon, Liber & Co Demerara Syrup, El Guapo Bitters

Level up with Garrison Brothers Small Batch Bourbon 24

Make it a twist featuring Cincoro Reposado Tequila 28



MANHATTAN 18

Knob Creek 7 Yr. Rye Whiskey, Antica Formula Sweet Vermouth, Angostura Bitters

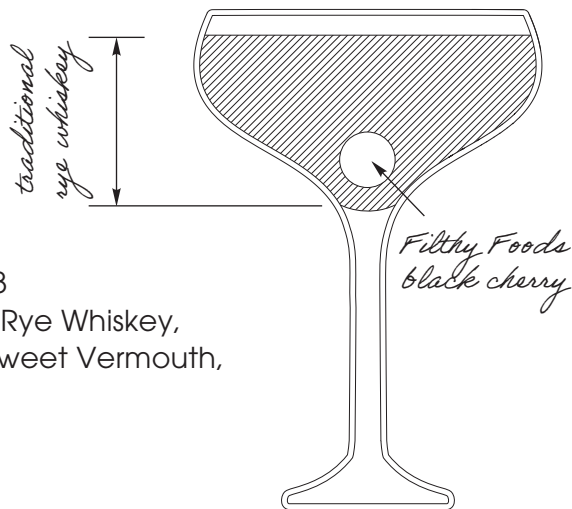

ELEMENT KEY	
	Timeless
	Vibrant
	Wellness
	Community
	Sustainable

candied ginger slice

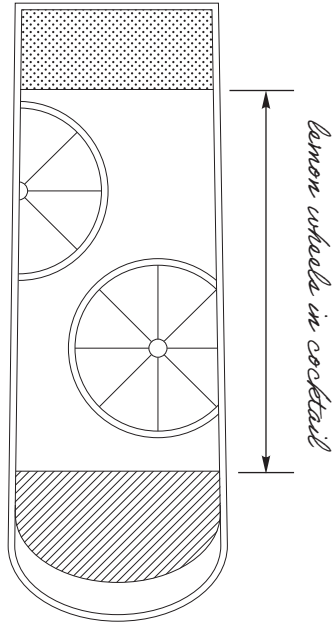

SEAMLESS 12
 Monin Vanilla, Passion
 Fruit Reàl, fresh lemon,
 Q Club Soda



DOMESTIC 6
 MICHELOB ULTRA
 COORS LIGHT
 MILLER LITE
 BUD LIGHT

IMPORTED 7
 CORONA EXTRA
 DOS EQUIS LAGER
 STELLA ARTOIS

CRAFT 7
 BLUE MOON BELGIAN WHITE
 DEEP ELLUM IPA
 MANHATTAN PROJECT HAZY IPA

**HARD SELTZERS
 & CIDERS** 7
 NOLA PUNCH CIDER
 TRULY WILD BERRY HARD SELTZER

ELEMENT KEY

-  Timeless
-  Vibrant
-  Wellness
-  Community
-  Sustainable

*dehydrated
 blood orange
 wheel*

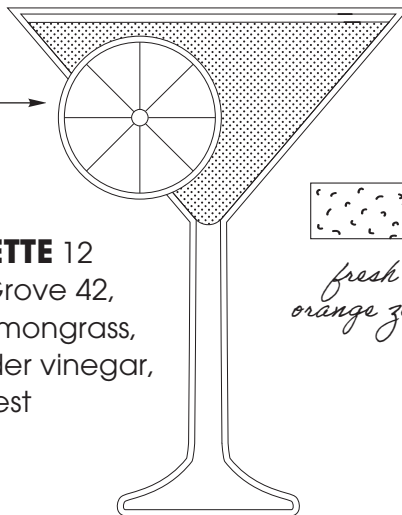



SILHOUETTE 12
 Seedlip Grove 42,
 Monin Lemongrass,
 apple cider vinegar,
 orange zest



*fresh
 orange zest*

White Wines

White Wines

<i>Intensity</i>							
Fruit	Tannin	Acidity					
							
●	○	◐	CHATEAU STE. MICHELLE • Riesling	Columbia Valley, Washington	11	15	42
○	○	●	SANTA MARGHERITA • Pinot Grigio	Valdadige, Veneto, Italy	17	24	66
○	◐	●	CHATEAU D'ESCLANS WHISPERING ANGEL • Rosé	Côtes de Provence, France	16	22	62
◐	○	◐	MERRYVALE • Sauvignon Blanc	Napa Valley, California	14	19	54
●	○	●	PINE RIDGE • Chenin Blanc/Viognier	California	12	16.5	48
●	◐	○	KENDALL-JACKSON VINTNER'S RESERVE • Chardonnay	California	14	19	54
◐	◐	○	ORIN SWIFT MANNEQUIN • Chardonnay	California	22	30	84

○ MIN ◐ MID ● MAX

Red Wines

Red Wines

<i>Intensity</i>							
Fruit	Tannin	Acidity					
●	○	◐	MEIOMI • Pinot Noir	California	6oz	9oz	BTL
◐	◐	○	BELLE GLOS BALADE • Pinot Noir	Santa Barbara County, California	16	22	64
○	●	●	BANFI • Chianti Classico	Tuscany, Italy	19	26	74
◐	●	◐	DUCKHORN • Merlot	Napa Valley, California	12	17	46
◐	●	◐	J. LOHR PURE PASO • Red Blend	Paso Robles, California	32	44	122
◐	●	◐	THE PRISONER UNSHACKLED • Cabernet Sauvignon	California	17	24	74
◐	●	◐	DAOU • Cabernet Sauvignon	Paso Robles, California	15	21	58
◐	●	◐			16	22	62

○ MIN ◐ MID ● MAX

NA Beverages

FIZZ

RED BULL ENERGY DRINK 7

RED BULL SUGARFREE 7

S.PELLEGRINO SPARKLING
MINERAL WATER 500ML 5

S.PELLEGRINO ESSENZA
ASSORTED 6

FLAT

ACQUA PANNA 500ML 5

With sincere gratitude we give thanks
to our partners who build community
and promote sustainability.

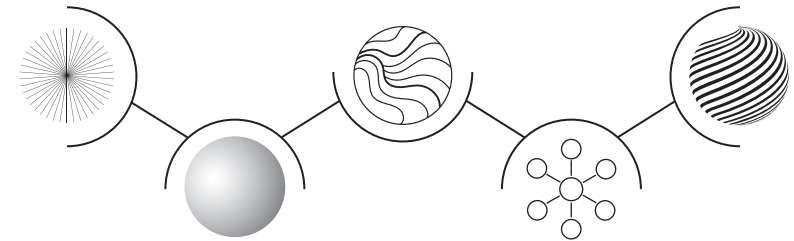



COMMUNITY

Owen's American Tonic: Helping to raise awareness to Fields of Honor in support of families of fallen or disabled military and first responders with more than 35,000 scholarships awarded since 2007.

21 Seeds Tequila: Female-founded infused tequila inspiring you to gather your tribe of friends new and old, cross borders, share ideas, and make connections.

Appleton Estate Rum: In 1997, Dr. Joy Spence became the first woman appointed master blender in the industry, an amazing milestone for women across the world!

Woodford Reserve Bourbon: Woodford Reserve works closely with Old Friend Farms, where racing thoroughbreds are sent to retire and raise awareness of the importance of equine aftercare.

High West Bourbon: Pledged \$1,000,000 over the next three years to organizations that are working to protect the West from wildfires – including Wildland Firefighter Foundation, Protect Our Winters (POW), and American Prairie Reserve.

Monin: Honored to partner with organizations making a positive impact including Grounds for Health, Children of Restaurant Employees (CORE), and Step Up for Students.



SUSTAINABILITY

Patrón Tequila: Patrón was the first distillery to install a natural gas pipeline, which acts as its main energy source and helps reduce CO2 emissions in the atmosphere.

Absolut Vodka: For the past four years, Absolut has been using so-called waste spirits to reduce use of liquefied propane gas (LPG) to generate energy at their Nöbbelöv distillery.

Seedlip: Seedlip is a 1% for the Planet member, giving 1% of global annual revenues to environmental charities dedicated to celebrating and protecting the planet.