

ELEMENTS OF DRINK DESIGN

Much like a well-designed object, a well-crafted cocktail takes into account the contributions of each element and how they play against each other. Balance and tension, comfort and elevation, the nuances of technique and ingredient make each cocktail unique.

The Elements of a Cocktail

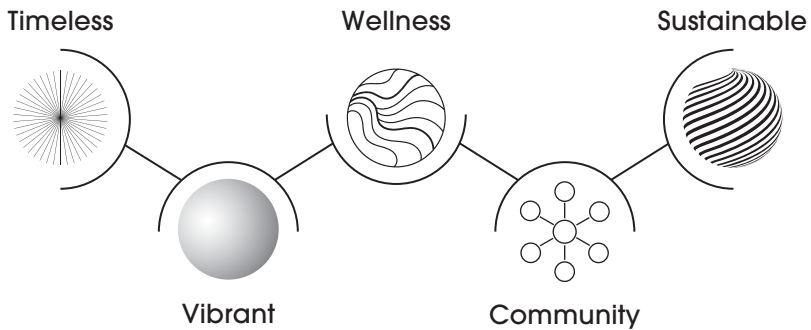



BUILD YOUR OWN HIGHBALL 14

Choose your Spirit:

VODKA

- Tito's Handmade
- Belvedere Organic
- Grey Goose

TEQUILA

- Herradura Silver
- Casamigos Reposado
- Milagro Añejo

BOURBON

- Bulleit
- Maker's Mark
- Woodford Reserve

Choose your Mixer:

- Q Club Soda
- Owen's Rio Red Grapefruit
- Owen's American Tonic
- Q Ginger Ale
- Owen's Ginger Beer



AMERICANO HIGHBALL 16

- Campari, Antica Formula Sweet Vermouth, Q Club Soda

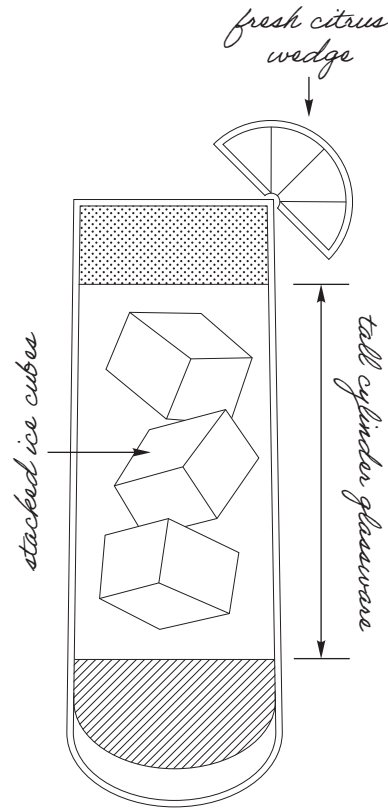

composed of an alcoholic base spirit and a larger proportion of a non-alcoholic mixer.



OF ALL THINGS 14

- 21 Seeds Grapefruit Hibiscus
- Tequila, Aperol, Barmalade
- Grapefruit-Elderflower,
- fresh lime, rhubarb bitters,
- Lunetta Prosecco

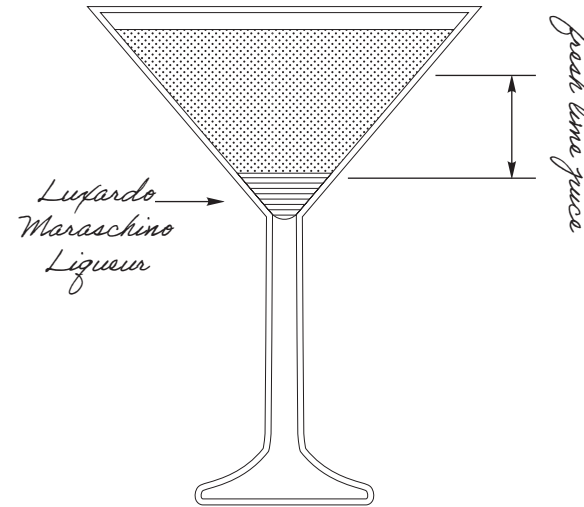

THE LAST WORD MARTINI 16

- Hendrick's Gin, green chartreuse,
- Luxardo Maraschino Liqueur,
- fresh lime



Make it smoky with Dos Hombres Mezcal 18

edible micro flowers

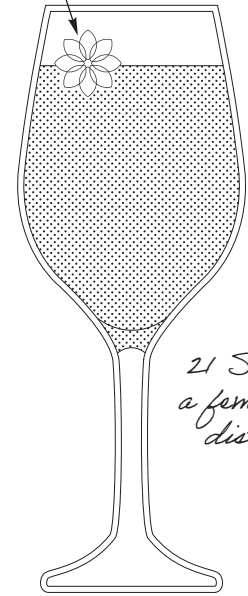

21 Seeds is a female-led distillery

ELEMENT KEY

 Timeless

 Vibrant

 Wellness

 Community

 Sustainable

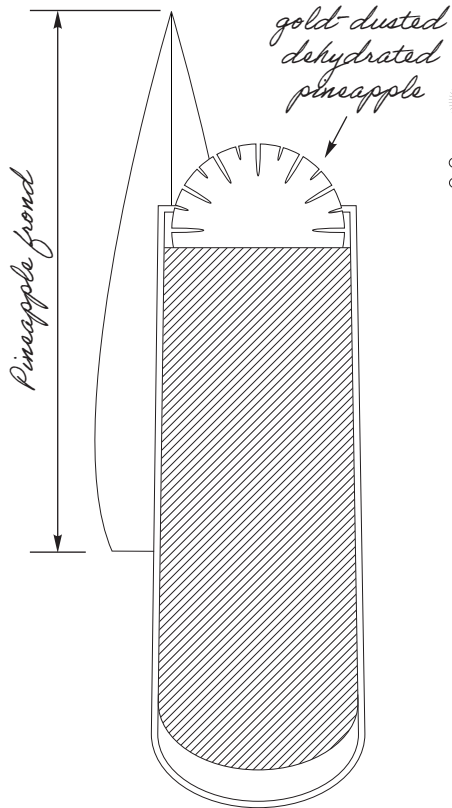

JUNGLE BIRD 12
 Appleton Estate Signature Blend Rum, Campari, Liber & Co. Pineapple Gum Syrup, fresh lime, pineapple juice

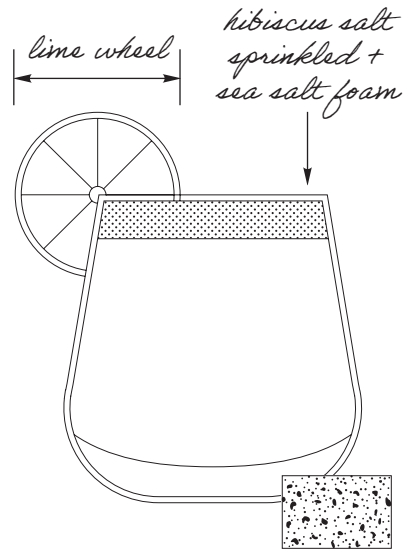
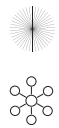

*spiced/smoked version:
 tajin rim + chili threads*

ELEMENT KEY	
	Timeless
	Vibrant
	Wellness
	Community
	Sustainable

MARGARITA 14
 Patrón Silver Tequila, Italicus Rosolio di Bergamotto, fresh lime, Monin Agave Nectar

- Level up with Herradura Reposado 16*
- Make it spicy with Ancho Reyes Chile Liqueur 16*
- Try it smoky with Dos Hombres Mezcal 18*



CLASSIC MARTINI

DRY / STIRRED 16
 The Botanist Gin or Ketel One Vodka, Carpano Dry Vermouth, orange bitters, lemon twist

DIRTY / SHAKEN 15
 Tito's Handmade Vodka, Carpano Bianco Vermouth, house brine, Filthy Foods Olive Accoutrements

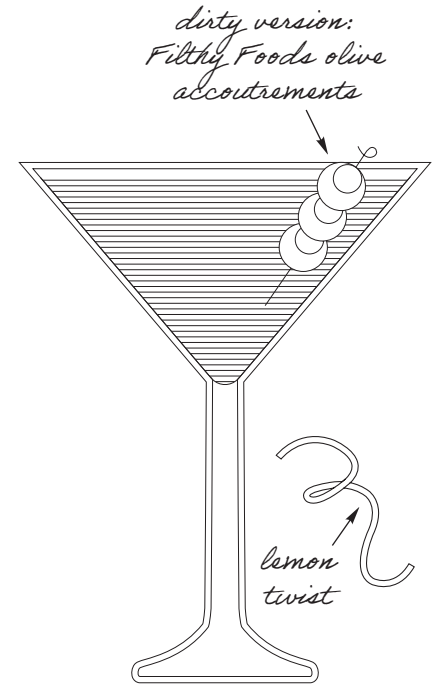

ESPRESSO MARTINI 16
 Absolut Vodka, Kahlúa, fresh espresso
Twist it up with Casamigos Reposado Tequila 19

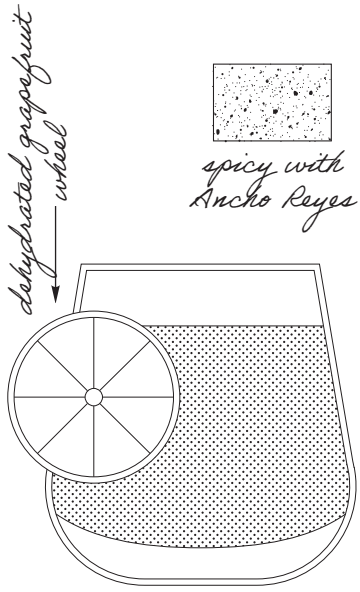

originally called the "De Rigueur" in cocktail books

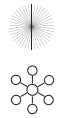

BROWN DERBY 16

Woodford Reserve Bourbon, fresh grapefruit, barrel-aged maple syrup, orange bitters

Spice it up with Ancho Reyes Chile Liqueur 17

Filthy Foods black cherry

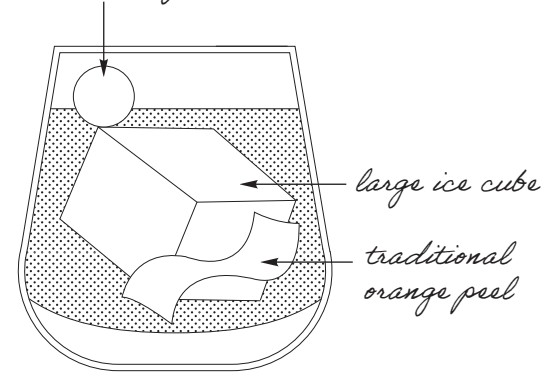

OLD FASHIONED 16

High West Bourbon, Liber & Co Demerara Syrup, El Guapo Bitters



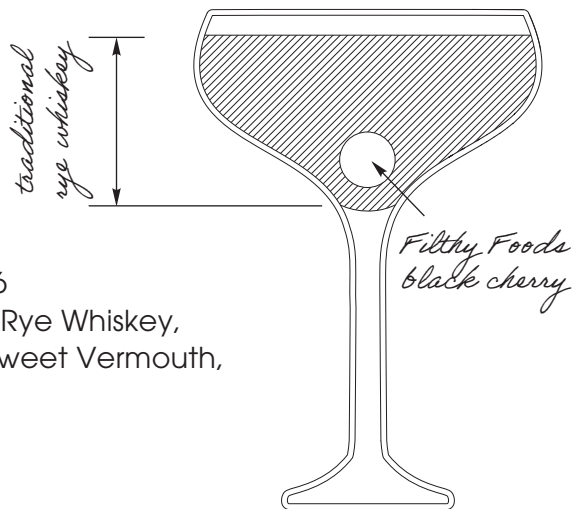

Level up with Garrison Brothers Small Batch Bourbon 18

Make it a twist featuring Cincoro Reposado Tequila 21



MANHATTAN 16

Knob Creek 7 Yr. Rye Whiskey, Antica Formula Sweet Vermouth, Angostura Bitters

ELEMENT KEY	
	Timeless
	Vibrant
	Wellness
	Community
	Sustainable

candied ginger slice

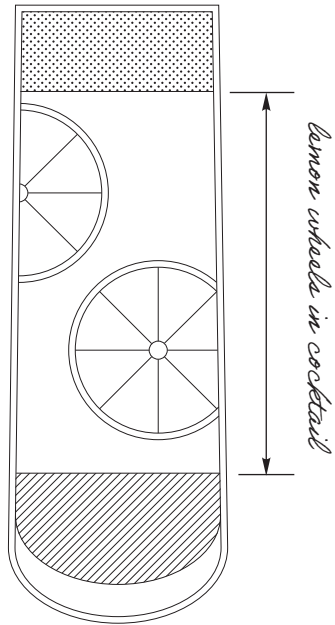

SEAMLESS 8

Monin Vanilla, Passion Fruit Reàl, fresh lemon, Q Club Soda



dehydrated blood orange wheel



fresh orange zest



SILHOUETTE 11

Seedlip Grove 42, Monin Lemongrass, apple cider vinegar, orange zest



ELEMENT KEY	
	Timeless
	Vibrant
	Wellness
	Community
	Sustainable

DOMESTIC 7

- MICHELOB ULTRA
- COORS LIGHT
- MILLER LITE
- BUD LIGHT
- BUDWEISER

IMPORTED 8

- CORONA PREMIER
- DOS EQUIS LAGER
- HEINEKEN
- PERONI
- STELLA ARTOIS
- GUINNESS
- MODELO ESPECIAL

NON-ALCOHOLIC 9

- HEINEKEN 0.0 NA LAGER
- ATHLETIC BREWING CO
- RUN WILD NA IPA

CRAFT

- SAMUEL ADAMS
- BOSTON LAGER 7
- SAMUEL ADAMS SEASONAL 7
- NEW BELGIUM FAT TIRE ALE 8
- NEW BELGIUM VOODOO
- RANGER JUICY HAZE IPA 9
- BLUE MOON BELGIAN WHITE 8
- WICKED WEED
- PERNICIOUS IPA 9
- SYCAMORE
- MOUNTAIN CANDY IPA 9
- YUENGLING
- AMERICAN LAGER 7

HARD SELTZERS & CIDERS

- ANGRY ORCHARD
- HARD CIDER 8
- FLAT ROCK HARD CIDER 8
- WHITE CLAW MANGO
- HARD SELTZER 8
- WHITE CLAW BLACK CHERRY
- HARD SELTZER 8
- TRULY WILD BERRY
- HARD SELTZER 8
- HIGH NOON
- VODKA HARD SELTZER 12

<i>Intensity</i>									
Fruit	Tannin	Acidity					6oz	9oz	BTL
●	○	●	LUNETTA • Prosecco Brut	Veneto, Italy (187ml)					16
●	○	○	CHANDON • Sparkling Rosé	California (187ml)					15
○	○	●	MOËT & CHANDON IMPÉRIAL • Brut Rosé	Champagne, France (187ml)					30
●	○	○	CHATEAU STE. MICHELLE • Riesling	Columbia Valley, Washington		12	15		48
○	○	●	SANTA MARGHERITA • Pinot Grigio	Valdadige, Veneto, Italy		18	25		69
○	○	●	ROSE GOLD • Rosé	Côtes de Provence, France		15	21		58
○	○	●	DECOY BY DUCKHORN • Sauvignon Blanc	California		14	17		54
●	○	●	PINE RIDGE • Chenin Blanc/Viognier	California		12	16.5		48
●	○	○	KENDALL-JACKSON VINTNER'S RESERVE • Chardonnay	California		13	16		52

○ MIN ○ MID ● MAX

Red Wines

Red Wines

<i>Intensity</i>									
Fruit	Tannin	Acidity					6oz	9oz	BTL
●	○	●	ELOUAN • Pinot Noir	Oregon			13	18	52
○	●	●	BANFI • Chianti Classico	Tuscany, Italy			13	18	50
●	●	○	BENZIGER • Merlot	Sonoma County, California			14	19	56
○	●	●	CATENA VISTA FLORES • Malbec	Mendoza, Argentina			12	15	48
●	●	●	JOEL GOTT • Red Blend	Columbia Valley, Washington			14	19	54
●	●	●	TRIBUTE • Cabernet Sauvignon	California			12	16	48
●	●	●	FRANCISCAN ESTATE CORNERSTONE Cabernet Sauvignon	California			14	19	54
●	●	●	DAOU • Cabernet Sauvignon	Paso Robles, California			16	22	64

○ MIN ● MID ● MAX

BOARDS

 **LOCAL CHEESES** 16
assortment of
local cheeses, fruit,
local honey, crackers



 **CHARCUTERIE BOARD** 19
selection of local meats,
preserves, fruit,
toasted crostini

DIPS

 **FRENCH ONION DIP** 11
caramelized onions,
whipped tofu,
garlic, herbs,
house-made bbq chips

 **BAKED BUFFALO CHICKEN DIP** 12
grilled flatbread,
Gorgonzola,
fire-braised poulet

SNACKS

 **DEVILED EGGS** 8
 applewood-smoked
bacon, chives,
paprika

TWISTED PASTRY PINWHEEL 9
pepperoni, herbs,
Thomasville tomme,
garlic, tomato preserves

 **PRETZEL BITES** 7
 whole grain mustard,
pickled red onions

SWEETS

 **CHOCOLATE TORTE** 7
chocolate ganache,
flourless cake,
whipped cream

FINANCIER 7
brown butter &
almond cake,
macerated berries,
Chantilly cream

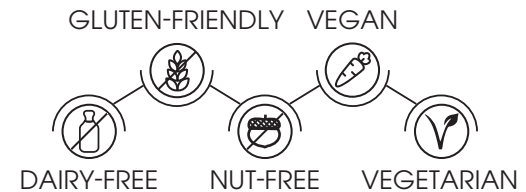

Gluten-friendly bread available upon request.

*Consuming raw or undercooked meats, poultry, seafood, shellfish or eggs may increase your risk of foodborne illness.

Please notify us of any food allergy.

HOT COFFEE & TEA

STANCE COFFEE 5

NUMI HOT TEA 6

OTHER BEVERAGES

FRESH-SQUEEZED
ORANGE JUICE 5

ICED TEA 4

COCA-COLA PRODUCT 4

FIZZ

RED BULL ENERGY DRINK 9

RED BULL SUGARFREE 9

S.PELLEGRINO SPARKLING
MINERAL WATER 500ML 8

S.PELLEGRINO ESSENZA
ASSORTED 12

FLAT

ACQUA PANNA 500ML 8

With sincere gratitude we give thanks
to our partners who build community
and promote sustainability.

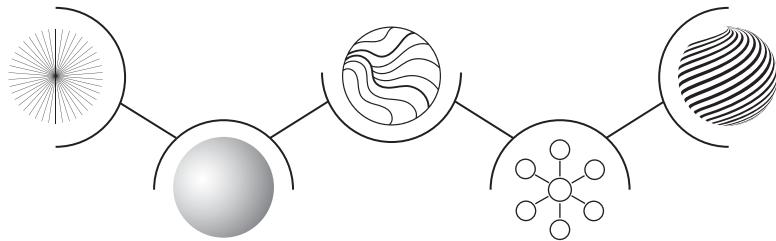

COMMUNITY

Owen's American Tonic: Helping to raise awareness to Fields of Honor in support of families of fallen or disabled military and first responders with more than 35,000 scholarships awarded since 2007.

21 Seeds Tequila: Female-founded infused tequila inspiring you to gather your tribe of friends new and old, cross borders, share ideas, and make connections.

Appleton Estate Rum: In 1997, Dr. Joy Spence became the first woman appointed master blender in the industry, an amazing milestone for women across the world!

Woodford Reserve Bourbon: Woodford Reserve works closely with Old Friend Farms, where racing thoroughbreds are sent to retire and raise awareness of the importance of equine aftercare.

High West Bourbon: Pledged \$1,000,000 over the next three years to organizations that are working to protect the West from wildfires – including Wildland Firefighter Foundation, Protect Our Winters (POW), and American Prairie Reserve.

Monin: Honored to partner with organizations making a positive impact including Grounds for Health, Children of Restaurant Employees (CORE), and Step Up for Students.

SUSTAINABILITY

Patrón Tequila: Patrón was the first distillery to install a natural gas pipeline, which acts as its main energy source and helps reduce CO2 emissions in the atmosphere.

Absolut Vodka: For the past four years, Absolut has been using so-called waste spirits to reduce use of liquefied propane gas (LPG) to generate energy at their Nöbbelöv distillery.

Seedlip: Seedlip is a 1% for the Planet member, giving 1% of global annual revenues to environmental charities dedicated to celebrating and protecting the planet.