

## ELEMENTS OF DRINK DESIGN

Much like a well-designed object, a well-crafted cocktail takes into account the contributions of each element and how they play against each other. Balance and tension, comfort and elevation, the nuances of technique and ingredient make each cocktail unique.

### *The Elements of a Cocktail*

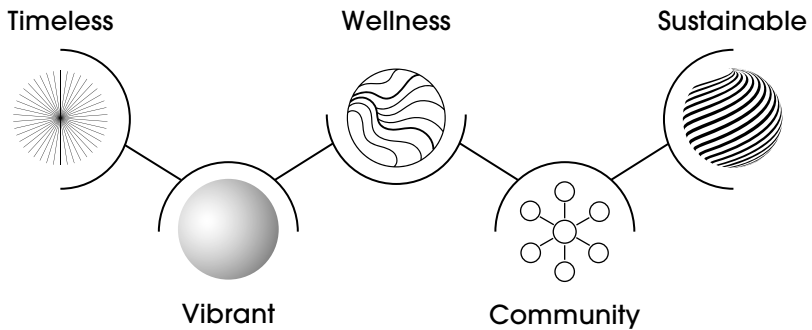



**BUILD YOUR OWN HIGHBALL 16**

*Choose your Spirit:*

**VODKA**

- Tito's Handmade
- Belvedere Organic
- Grey Goose

**TEQUILA**

- Herradura Silver
- Casamigos Reposado
- Milagro Añejo

**BOURBON**

- Bulleit
- Maker's Mark
- Woodford Reserve

*Choose your Mixer:*

- Q Club Soda
- Owen's Rio Red Grapefruit
- Owen's American Tonic
- Q Ginger Ale
- Owen's Ginger Beer

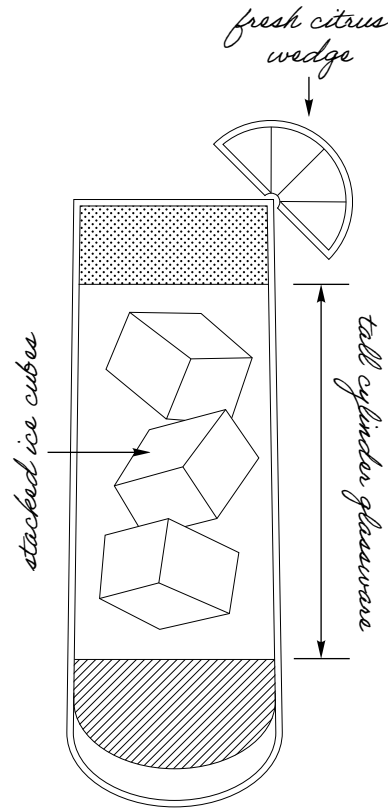

*composed of an alcoholic base spirit and a larger proportion of a non-alcoholic mixer.*



**AMERICANO HIGHBALL 17**

- Campari, Antica Formula Sweet Vermouth, Q Club Soda

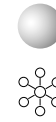

**OF ALL THINGS 16**

- 21 Seeds Grapefruit Hibiscus
- Tequila, Aperol, Barmalade
- Grapefruit-Elderflower,
- fresh lime, rhubarb bitters,
- Lunetta Prosecco

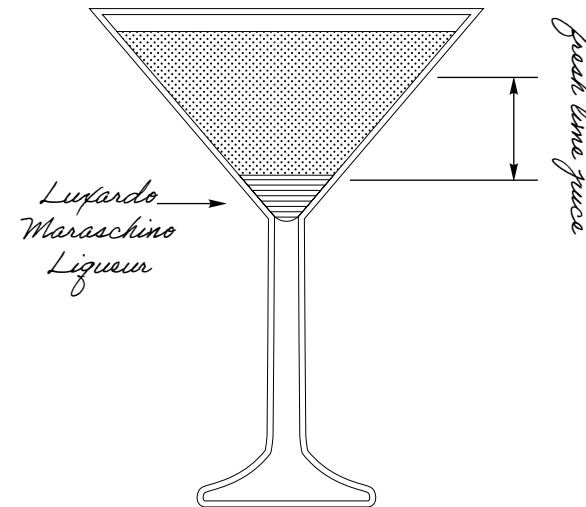

*edible micro flowers*

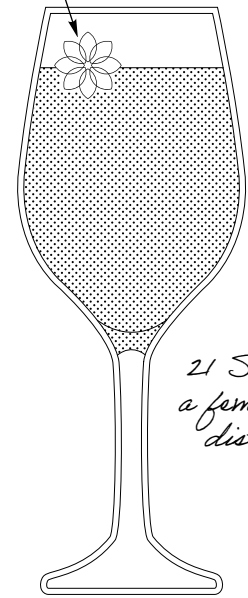

*21 Seeds is a female-led distillery*



**THE LAST WORD MARTINI 16**

- Hendrick's Gin, green chartreuse,
- Luxardo Maraschino Liqueur,
- fresh lime

*Make it smoky with Dos Hombres Mezcal 18*

ELEMENT KEY	
	Timeless
	Vibrant
	Wellness
	Community
	Sustainable

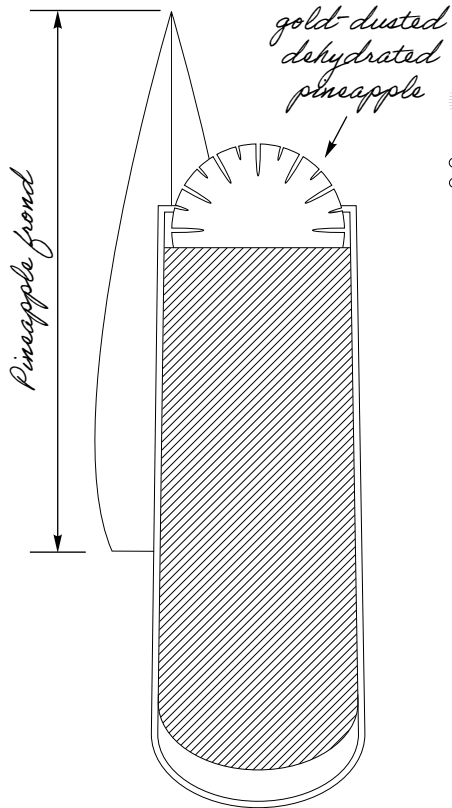

**JUNGLE BIRD 16**  
 Appleton Estate Signature Blend Rum, Campari, Liber & Co. Pineapple Gum Syrup, fresh lime, pineapple juice

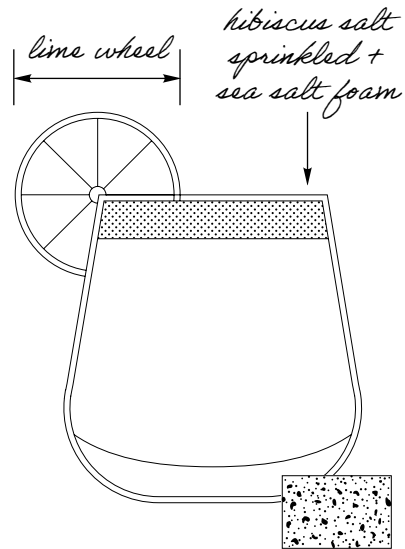
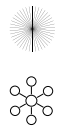

*spiced/smoked version:  
 tajin rim + chili threads*

ELEMENT KEY	
	Timeless
	Vibrant
	Wellness
	Community
	Sustainable

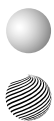

**MARGARITA 16**  
 Patrón Silver Tequila, Italicus Rosolio di Bergamotto, fresh lime, Monin Agave Nectar

*Level up with Herradura Reposado 18*

*Make it spicy with Ancho Reyes*

*Chile Liqueur 18*

*Try it smoky with Dos Hombres Mezcal 18*



**CLASSIC MARTINI**

**DRY / STIRRED 17**  
 The Botanist Gin or Ketel One Vodka, Carpano Dry Vermouth, orange bitters, lemon twist



**DIRTY / SHAKEN 17**  
 Tito's Handmade Vodka, Carpano Bianco Vermouth, house brine, Filthy Foods Olive Accoutrements

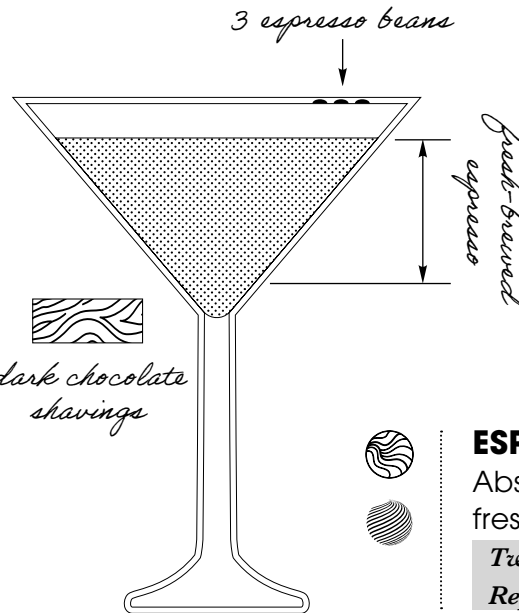
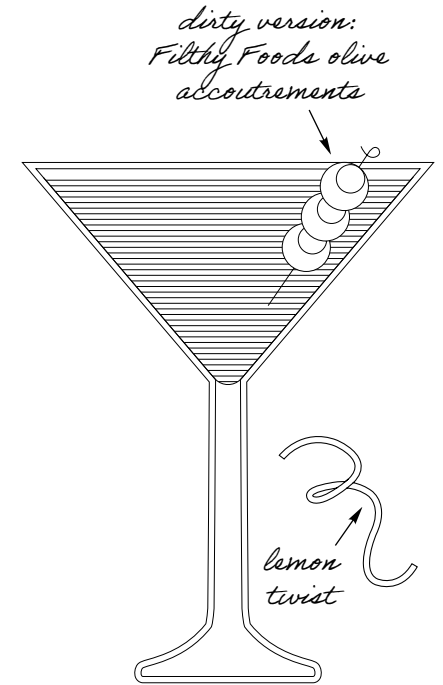

**ESPRESSO MARTINI 18**  
 Absolut Vodka, Kahlúa, fresh espresso  
*Twist it up with Casamigos Reposado Tequila 22*



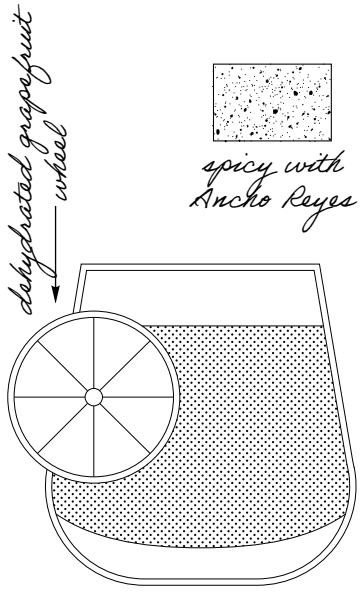

originally called the "De Requieur" in cocktail books

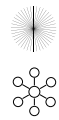

**BROWN DERBY** 16

Woodford Reserve Bourbon, fresh grapefruit, barrel-aged maple syrup, orange bitters

*Spice it up with Ancho Reyes Chile Liqueur 18*

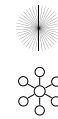
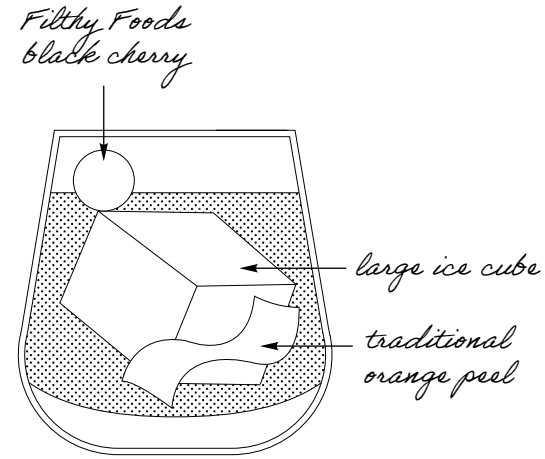

**OLD FASHIONED** 16

High West Bourbon, Liber & Co Demerara Syrup, El Guapo Bitters

*Level up with Garrison Brothers Small Batch Bourbon 24*

*Make it a twist featuring Cincoro Reposado Tequila 30*

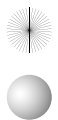

**MANHATTAN** 18

Knob Creek 7 Yr. Rye Whiskey, Antica Formula Sweet Vermouth, Angostura Bitters

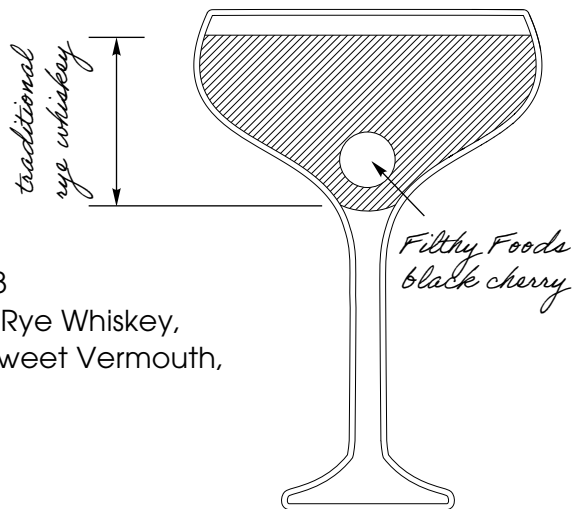

ELEMENT KEY	
	Timeless
	Vibrant
	Wellness
	Community
	Sustainable

*candied ginger slice*

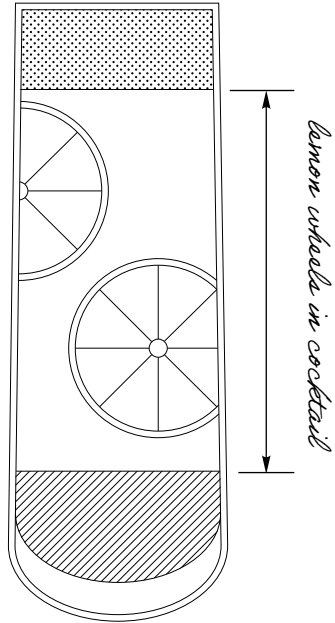

**SEAMLESS** 12

Monin Vanilla, Passion Fruit Reàl, fresh lemon, Q Club Soda

*dehydrated blood orange wheel*

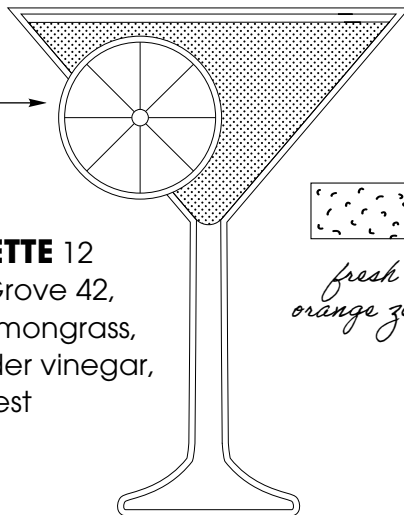

*fresh orange zest*



**SILHOUETTE** 12

Seedlip Grove 42, Monin Lemongrass, apple cider vinegar, orange zest

ELEMENT KEY	
	Timeless
	Vibrant
	Wellness
	Community
	Sustainable

**DOMESTIC** 7

- MICHELOB ULTRA
- COORS LIGHT
- MILLER LITE
- BUD LIGHT
- BUDWEISER

**IMPORTED** 9

- CORONA EXTRA
- DOS EQUIS LAGER
- HEINEKEN
- PERONI
- STELLA ARTOIS
- GUINNESS
- MODELO ESPECIAL

**NON-ALCOHOLIC** 8

- HEINEKEN 0.0 NA LAGER
- ATHLETIC BREWING CO
- RUN WILD NA IPA

**CRAFT** 9

- NIGHT SHIFT NITE LITE LAGER
- SAMUEL ADAMS
- WICKED EASY SESSION IPA
- SAMUEL ADAMS SEASONAL
- BLUE MOON BELGIAN WHITE
- NIGHT SHIFT WHIRLPOOL PALE ALE
- NEW BELGIUM VOODOO
- RANGER JUICY HAZE IPA
- SAMUEL ADAMS WICKED HAZY IPA
- HARPOON IPA

**HARD SELTZERS & CIDERS**

- ANGRY ORCHARD
- HARD CIDER 8
- ARTIFACT CIDER PROJECT 9
- WHITE CLAW MANGO
- HARD SELTZER 8
- WHITE CLAW BLACK
- CHERRY HARD SELTZER 8
- TRULY WILD BERRY
- HARD SELTZER 8
- HIGH NOON WATERMELON
- VODKA HARD SELTZER 8

White Wines

White Wines

<i>Intensity</i>									
Fruit	Tannin	Acidity					6oz	9oz	BTL
●	○	●	LUNETTA • <b>Prosecco Brut</b>	Veneto, Italy (187ml)			-	-	9
●	○	○	CHANDON • <b>Sparkling Rosé</b>	California (187ml)			-	-	15
○	○	●	MOËT & CHANDON IMPÉRIAL • <b>Brut Rosé</b>	Champagne, France (187ml)			-	-	30
○	○	●	VEUVE CLICQUOT YELLOW LABEL • <b>Brut</b>	Champagne, France			33	-	130
●	○	○	CHATEAU STE. MICHELLE • <b>Riesling</b>	Columbia Valley, Washington			10	14	40
○	○	●	ZENATO • <b>Pinot Grigio</b>	delle Venezie, Italy			11	15	44
○	○	●	SANTA MARGHERITA • <b>Pinot Grigio</b>	Valdadige, Veneto, Italy			19	26	74
○	○	●	CHATEAU D'ESCLANS WHISPERING ANGEL • <b>Rosé</b>	Côtes de Provence, France			16	22	62
○	○	●	J. LOHR FLUME CROSSING • <b>Sauvignon Blanc</b> (On Tap)	Arroyo Seco, California			12	17	-
○	○	○	MERRYVALE • <b>Sauvignon Blanc</b>	Napa Valley, California			21	29	80
●	○	●	PINE RIDGE • <b>Chenin Blanc/Viognier</b> (On Tap)	California			10	14	-
●	○	○	WENTE RIVA RANCH • <b>Chardonnay</b> (On Tap)	Arroyo Seco & Monterey, California			13	18	-

○ MIN ○ MID ● MAX

Red Wines

Red Wines



				6oz	9oz	BTL	
①	○	●	ELOUAN • <b>Pinot Noir</b> <i>(On Tap)</i>	Oregon	15	21	-
①	●	○	BELLE GLOS BALADE • <b>Pinot Noir</b>	Santa Barbara County, California	22	30	84
①	●	●	DECOY BY DUCKHORN • <b>Merlot</b>	Sonoma, California	17	24	66
①	●	●	TRIBUTE • <b>Cabernet Sauvignon</b>	California	10	14	40
①	●	●	CHARLES & CHARLES <b>Cabernet Sauvignon/Syrah</b> <i>(On Tap)</i>	Columbia Valley, Washington	12	17	-
①	●	●	JOEL GOTT 815 • <b>CABERNET SAUVIGNON</b> <i>(On Tap)</i>	California	15	21	-
①	●	●	J. LOHR PURE PASO • <b>Red Blend</b>	Paso Robles, California	19	26	74
①	●	●	THE PRISONER WINE COMPANY UNSHACKLED • <b>Cabernet Sauvignon</b>	California	19	26	74
①	●	●	DAOU • <b>Cabernet Sauvignon</b>	Paso Robles, California	19	26	74

○ MIN ● MID ● MAX

---

**TEQUILA**

- CASAMIGOS BLANCO 14
- CASAMIGOS REPOSADO 16
- CASAMIGOS AÑEJO 18
- CIERTO PRIVATE COLLECTION AÑEJO 40
- CINCORO BLANCO 22
- CINCORO REPOSADO 28
- CINCORO AÑEJO 35
- CLASE AZUL REPOSADO 40
- DON JULIO 1942 AÑEJO 45
- PATRÓN SILVER 14
- PATSCH REPOSADO 25

**BOURBON & WHISKEY**

- ANGEL'S ENVY BOURBON 16
- BASIL HAYDEN BOURBON 16
- BLANTON'S BOURBON 25
- EAGLE RARE 10 YR BOURBON 14
- GARRISON BROTHERS SMALL BATCH BOURBON 20
- GENTLEMAN JACK WHISKEY 14
- HIGH WEST DOUBLE RYE 14
- KNOB CREEK RYE 14
- MAKER'S MARK PRIVATE SELECTION OMNI SEAPORT BARREL BOURBON 18
- WHISTLEPIG 10YR RYE 20
- WOODFORD RESERVE BOURBON 14

---

**HOT COFFEE & TEA**

- STANCE COFFEE 5
- NUMI HOT TEA 5
- ESPRESSO 5
- MACCHIATO 6
- CAPPUCCINO 6
- AMERICANO 5

---

**FIZZ**

- RED BULL ENERGY DRINK 6
- RED BULL SUGARFREE 6
- S.PELLEGRINO SPARKLING MINERAL WATER 500ML 5
- S.PELLEGRINO ESSENZA ASSORTED 6

**FLAT**

- ACQUA PANNA 500ML 5

VIEW MENU

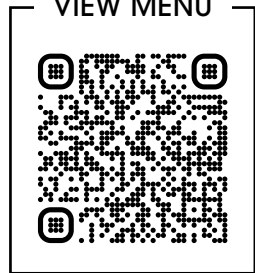

18% service charge will be added all parties of 6 or more.



With sincere gratitude we give thanks to our partners who build community and promote sustainability.

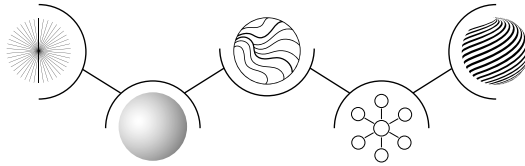

## COMMUNITY

**Owen's American Tonic:** Helping to raise awareness to Fields of Honor in support of families of fallen or disabled military and first responders with more than 35,000 scholarships awarded since 2007.

**21 Seeds Tequila:** Female-founded infused Tequila inspiring you to gather your tribe of friends new and old, cross borders, share ideas, and make connections.

**Appleton Estate Rum:** In 1997, Dr. Joy Spence became the first woman appointed master blender in the industry, an amazing milestone for women across the world!

**Woodford Reserve Bourbon:** Woodford works closely with Old Friend Farms, where racing thoroughbreds are sent to retire and raise awareness of the importance of equine aftercare.

**High West Bourbon:** Pledged \$1,000,000 over the next three years to organizations that are working to protect the West from wildfires – including “Wildland Firefighter Foundation”, “Protect Our Winters” (POW), and “American Prairie Reserve”.

**Monin:** Honored to partner with organizations making a positive impact including Grounds for Health, Children of Restaurant Employees (CORE), and Step Up for Students.



## SUSTAINABILITY

**Patrón Tequila:** Patrón was the first distillery to install a natural gas pipeline, which acts as its main energy source and helps reduce CO2 emissions in the atmosphere.

**Absolut Vodka:** For the past four years, Absolut has been using so-called waste spirits to reduce use of liquefied propane gas (LPG) to generate energy at their Nöbbelöv distillery.

**Seedlip:** Seedlip is a 1% for the Planet member, giving 1% of global annual revenues to environmental charities dedicated to celebrating and protecting the planet.