

ELEMENTS OF DRINK DESIGN

Much like a well-designed object, a well-crafted cocktail takes into account the contributions of each element and how they play against each other. Balance and tension, comfort and elevation, the nuances of technique and ingredient make each cocktail unique.

The Elements of a Cocktail

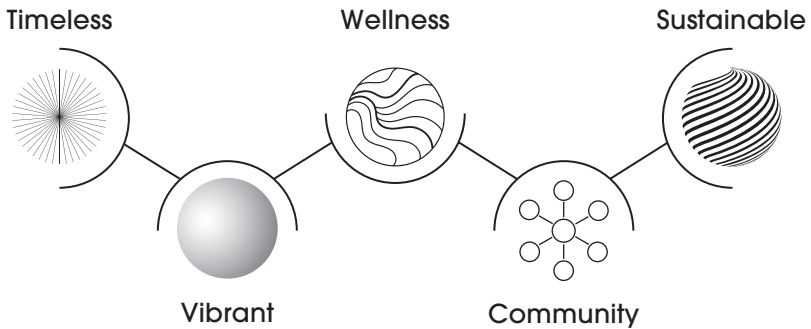



BUILD YOUR OWN HIGHBALL 12

Choose your Spirit:

VODKA

Tito's Handmade
Belvedere Organic
Grey Goose

TEQUILA

Herradura Silver
Casamigos Reposado
Milagro Añejo

BOURBON

Bulleit
Maker's Mark
Woodford Reserve

Choose your Mixer:

Q Club Soda
Owen's Rio Red Grapefruit
Owen's American Tonic
Q Ginger Ale
Owen's Ginger Beer

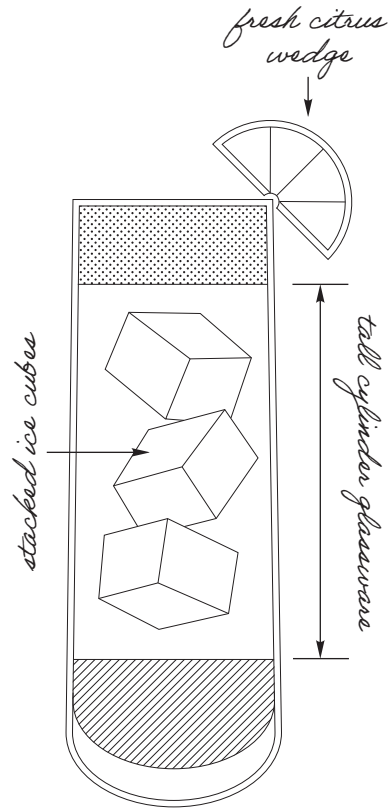

composed of an alcoholic base spirit and a larger proportion of a non-alcoholic mixer.



AMERICANO HIGHBALL 16

Campari, Antica Formula Sweet
Vermouth, Q Club Soda



OF ALL THINGS 16

21 Seeds Grapefruit Hibiscus
Tequila, Aperol, Barmalade
Grapefruit-Elderflower,
fresh lime, rhubarb bitters,
Lunetta Prosecco

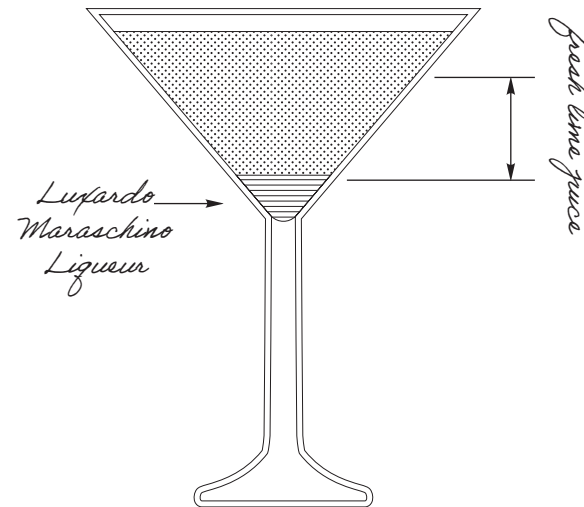

THE LAST WORD MARTINI 18

Hendrick's Gin, green chartreuse,
Luxardo Maraschino Liqueur,
fresh lime

Make it smoky with Dos Hombres Mezcal 17

edible micro flowers

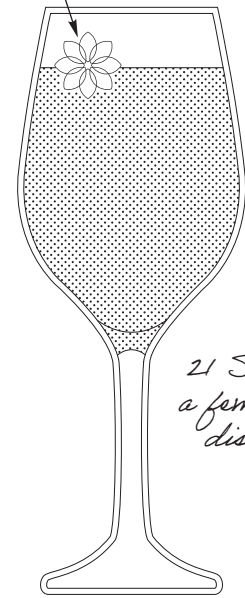

21 Seeds is a female-led distillery

ELEMENT KEY

Timeless

Vibrant

Wellness

Community

Sustainable

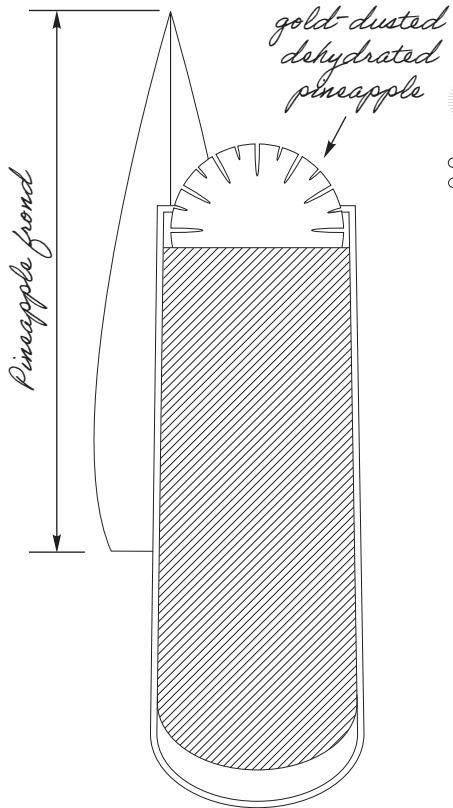

JUNGLE BIRD 14
 Appleton Estate Signature Blend Rum, Campari, Liber & Co. Pineapple Gum Syrup, fresh lime, pineapple juice

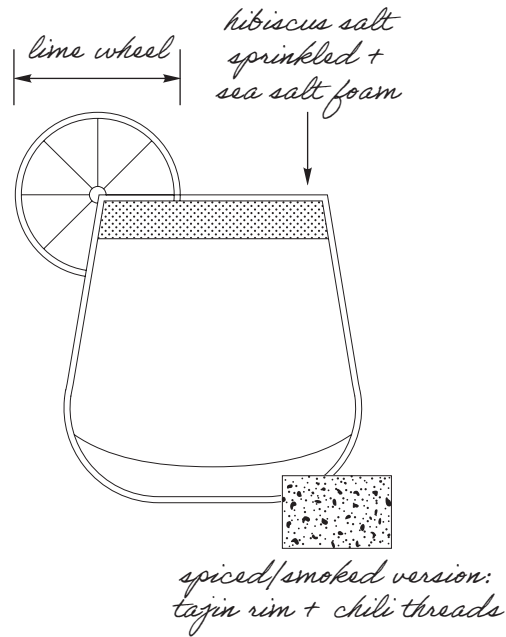
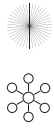

MARGARITA 14
 Patrón Silver Tequila, Italicus Rosolio di Bergamotto, fresh lime, Monin Agave Nectar

Level up with Herradura Reposado 16

Make it spicy with Ancho Reyes Chile Liqueur 16

Try it smoky with Dos Hombres Mezcal 16

ELEMENT KEY	
	Timeless
	Vibrant
	Wellness
	Community
	Sustainable

CLASSIC MARTINI

DRY / STIRRED 14
 The Botanist Gin or Ketel One Vodka, Carpano Dry Vermouth, orange bitters, lemon twist

DIRTY / SHAKEN 14
 Tito's Handmade Vodka, Carpano Bianco Vermouth, house brine, Filthy Foods Olive Accoutrements

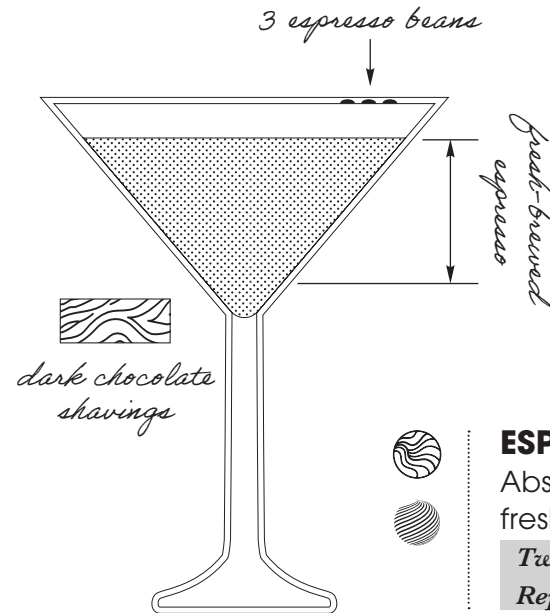
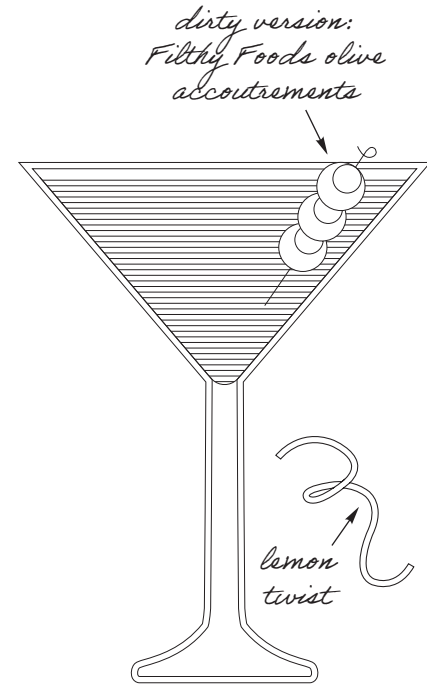

ESPRESSO MARTINI 16
 Absolut Vodka, Kahlúa, fresh espresso

Twist it up with Casamigos Reposado Tequila 18



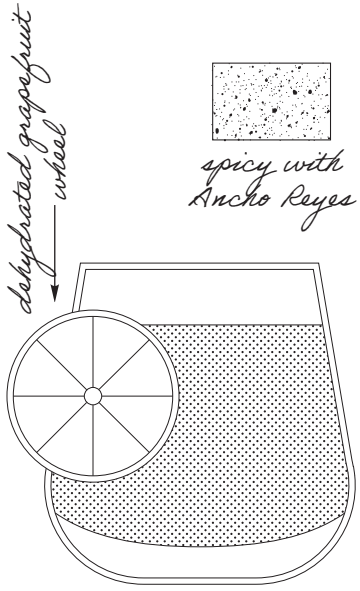

dehydrated grapefruit wheel

spicy with Ancho Reyes

originally called the "De Rigueur" in cocktail books

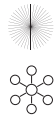

BROWN DERBY 14

Woodford Reserve Bourbon, fresh grapefruit, barrel-aged maple syrup, orange bitters

Spice it up with Ancho Reyes Chile Liqueur 15

Filthy Foods black cherry

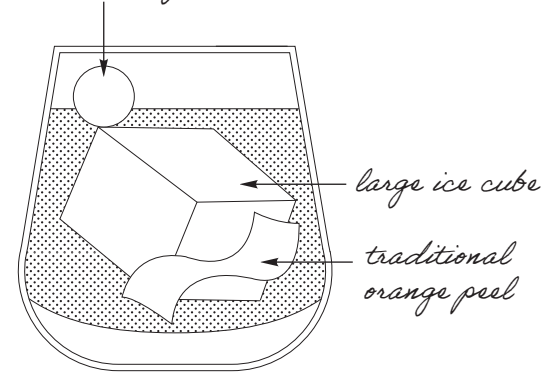

large ice cube

traditional orange peel



OLD FASHIONED 14

High West Bourbon, Liber & Co Demerara Syrup, El Guapo Bitters

Level up with Garrison Brothers Small Batch Bourbon 20

Make it a twist featuring Cincoro Reposado Tequila 24

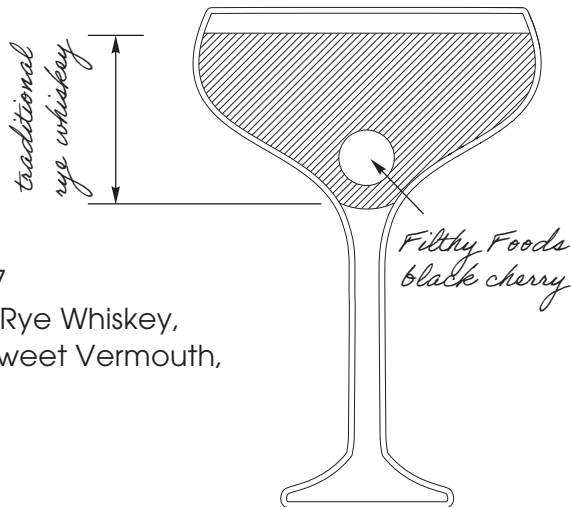

traditional rye whiskey

Filthy Foods black cherry



MANHATTAN 17

Knob Creek 7 Yr. Rye Whiskey, Antica Formula Sweet Vermouth, Angostura Bitters

ELEMENT KEY	
	Timeless
	Vibrant
	Wellness
	Community
	Sustainable

candied ginger slice

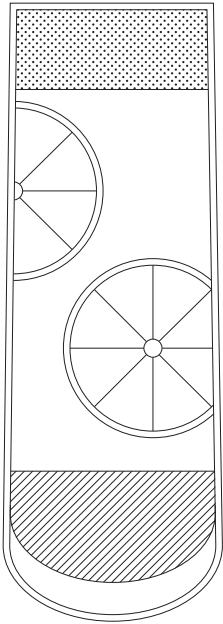

lemon wheels in cocktail



SEAMLESS 10
 Monin Vanilla, Passion Fruit Reäl, fresh lemon, Q Club Soda

dehydrated blood orange wheel



fresh orange zest



SILHOUETTE 14
 Seedlip Grove 42, Monin Lemongrass, apple cider vinegar, orange zest

ELEMENT KEY	
	Timeless
	Vibrant
	Wellness
	Community
	Sustainable

DOMESTIC

- MICHELOB ULTRA 6
- COORS LIGHT 6
- MILLER LITE 6
- BUD LIGHT 6
- BUDWEISER 6

IMPORTED

- CORONA LIGHT 7
- DOS EQUIS LAGER 7
- PERONI 7
- GUINNESS 7

NON-ALCOHOLIC

- HEINEKEN 0.0 NA LAGER 7
- ATHLETIC BREWING CO RUN
- WILD NA IPA 8

DRAFT

- DRAGOON IPA 8
- STELLA ARTOIS 7

CRAFT

- NEW BELGIUM VOODOO
- RANGER JUICY HAZE IPA 7
- BLUE MOON
- BELGIAN WHITE 7
- BARRIO BLONDE ALE 6

HARD SELTZERS & CIDERS

- ANGRY ORCHARD
- HARD CIDER 7
- CIDER CORPS MANGO
- FOXTROT CIDER 10
- WHITE CLAW MANGO HARD SELTZER 7
- WHITE CLAW BLACK CHERRY HARD SELTZER 7
- TRULY WILD BERRY HARD SELTZER 7
- HIGH NOON WATERMELON VODKA HARD SELTZER 7

White Wines

White Wines

Intensity



					6oz	9oz	BTL
●	○	●	LUNETTA • Prosecco Brut	Veneto, Italy (187ml)	-	-	12
●	○	○	CHANDON • Sparkling Rosé	California (187ml)	-	-	19
●	○	○	CHATEAU STE. MICHELLE • Riesling	Columbia Valley, Washington	10	14	38
○	○	●	SANTA MARGHERITA • Pinot Grigio	Valdadige, Veneto, Italy	18	24	70
○	○	●	CHATEAU D'ESCLANS WHISPERING ANGEL • Rosé	Côtes de Provence, France	16	21	62
○	○	●	DECOY BY DUCKHORN • Sauvignon Blanc	California	11	15	42
○	○	○	MERRYVALE • Sauvignon Blanc	Napa Valley, California	25	33	98
●	○	●	PINE RIDGE • Chenin Blanc/Viognier	California	9	12	34
●	○	○	KENDALL-JACKSON VINTNER'S RESERVE • Chardonnay	California	10	15	38
○	○	○	ORIN SWIFT MANNEQUIN • Chardonnay	California	27	35	106

○ MIN ○ MID ● MAX

Red Wines

Red Wines



			6oz	9oz	BTL
● ○ ●	MEIOMI • Pinot Noir	California	13	19	50
① ① ○	BELLE GLOS BALADE • Pinot Noir	Santa Barbara County, California	20	26	78
○ ● ●	BANFI • Chianti Classico	Tuscany, Italy	13	18	50
① ● ○	BENZIGER • Merlot	Sonoma County, California	11	15	42
① ● ●	DUCKHORN • Merlot	Napa Valley, California	27	35	106
① ① ①	LIBERTY SCHOOL • Cabernet Sauvignon	California	11	15	42
① ● ①	FRANCISCAN ESTATE CORNERSTONE Cabernet Sauvignon	California	12	17	46
① ● ①	UNSHACKLED BY THE PRISONER WINE COMPANY Cabernet Sauvignon	California	16	21	62

○ MIN ① MID ● MAX

BOARDS

CHEESE BOARD 16

boursin, arizona white cheddar, brie, tillamook, berries, castelvetrano olives, lavosh crackers, pecans

CHARCUTERIE BOARD 18

imported cured meats, pâté, cornichon, grain mustard, lavosh crackers

TUCSON FOR TWO 28

charcuterie & cheese, cornichon, grain mustard, grilled french bread, castelvetrano olives, fresh berries, nuts & lavosh, onion dip

DIPS

CARAMELIZED ONION DIP 12

sour cream & caramelized onion, toasted cumin, tortilla & kettle chips

 **MOKARA DIP** 18

tajín tahini hummus, cucumber coins, lavosh crackers

SNACKS



PECANS 10

candied "biggest pecan farm in the world" pecans with sumac spice



NUTS & BOLTS 8

worcestershire roasted chex, cheerios, pretzel sticks, peanuts & cashews

SWEETS



MACARONS & BONBONS 12

french macarons, toasted meringue, mae chocolate bonbons



MOKARA SWEET 14

greek yogurt, local true love honey, mango sauce, raisins, poppy seed gluten-friendly muffin top

CHEESECAKE 14

cajeta caramel, honey

LARGE PLATES

SHRIMP COCKTAIL 24

citrus-marinated shrimp,
avocado, cilantro, grilled
corn & red onions, crostini

LAMB LOLLIES 22

new zealand lamb rack,
hummus, mediterranean
tomato salad

PEAK BURGER 26

usda prime filet & ribeye,
bacon jam, arugula,
red onion & crispy sweet
potato fries

HOT COFFEE & TEA

STANCE COFFEE 4

NUMI HOT TEA 4

FIZZ

RED BULL ENERGY DRINK 4

RED BULL SUGARFREE 4

S.PELLEGRINO SPARKLING
MINERAL WATER 500ML 5

S.PELLEGRINO ESSENZA
ASSORTED 6

FLAT

ACQUA PANNA 500ML 5

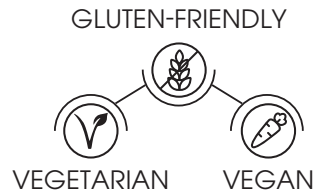

* Mokara Specialty

Gluten-friendly bread available upon request.

*Consuming raw or undercooked meats, poultry, seafood, shellfish or
eggs may increase your risk of foodborne illness.

Please notify us of any food allergy.

With sincere gratitude we give thanks
to our partners who build community
and promote sustainability.

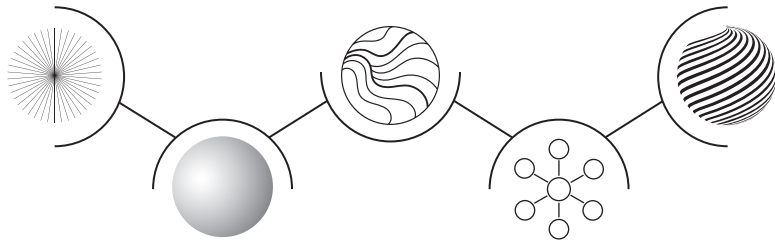

COMMUNITY

Owen's American Tonic: Helping to raise awareness to Fields of Honor in support of families of fallen or disabled military and first responders with more than 35,000 scholarships awarded since 2007.

21 Seeds Tequila: Female-founded infused tequila inspiring you to gather your tribe of friends new and old, cross borders, share ideas, and make connections.

Appleton Estate Rum: In 1997, Dr. Joy Spence became the first woman appointed master blender in the industry, an amazing milestone for women across the world!

Woodford Reserve Bourbon: Woodford Reserve works closely with Old Friend Farms, where racing thoroughbreds are sent to retire and raise awareness of the importance of equine aftercare.

High West Bourbon: Pledged \$1,000,000 over the next three years to organizations that are working to protect the West from wildfires – including Wildland Firefighter Foundation, Protect Our Winters (POW), and American Prairie Reserve.

Monin: Honored to partner with organizations making a positive impact including Grounds for Health, Children of Restaurant Employees (CORE), and Step Up for Students.



SUSTAINABILITY

Patrón Tequila: Patrón was the first distillery to install a natural gas pipeline, which acts as its main energy source and helps reduce CO2 emissions in the atmosphere.

Absolut Vodka: For the past four years, Absolut has been using so-called waste spirits to reduce use of liquefied propane gas (LPG) to generate energy at their Nöbbelöv distillery.

Seedlip: Seedlip is a 1% for the Planet member, giving 1% of global annual revenues to environmental charities dedicated to celebrating and protecting the planet.